

# COSYNA Progress Report 2011





## Content

---

- 6      **COSYNA Product 1: Pre-operational surface current fields**  
E.V. Stanev / F. Ziemer / J. Schulz-Stellenfleth / J. Seemann / J. Staneva / K. Wahle
- 10     **COSYNA Product 2: Hindcast/nowcast of SST and SSS in the German Bight**  
W. Petersen / E.V. Stanev / J. Staneva / J. Schulz-Stellenfleth / S. Grayek
- 12     **FerryBox**  
W. Petersen
- 16     **Wadden Sea poles**  
G. Flöser / K. Wirth / R. Riethmüller
- 18     **X-Band observation in the lateral ocean**  
F. Ziemer / J. Seemann
- 20     **Remote sensing**  
R. Röttgers/ H. Krasemann/ W. Schönfeld/ K. Heymann
- 22     **Gliders**  
L. Merckelbach / A. Werner / R. Kopetzky / B. Peters
- 24     **SCANFISH**  
R. Riethmüller / H. Thomas / H. Rinck / R. Kopetzky / R. Hofmeister / M. Schartau / K. Wirtz
- 26     **RV Ludwig Prandtl measuring systems**  
G. Flöser / M. Heineke
- 28     **Integrative sampling for the analysis of chemical contamination**  
A. Prange / D. Pröfrock / H. Helmholz
- 30     **First deployment of lander SedOBS**  
C. Winter (for the working group "Near bed observation systems")
- 32     **NuSOBS**  
J. Friedrich
- 33     **hypOO**  
O. Zielinski
- 34     **Underwater node**  
P. Fischer
- 37     **MOKI**  
H.-J. Hirche / J. Schulz
- 38     **Automated nucleic acid biosensor system for observing phytoplankton – AUTOSENS**  
K. Metfies
- 41     **Research platform Spiekeroog**  
T. Badewien
- 42     **Numerical models**  
E.V. Stanev / J. Staneva / K. Wahle / A. Behrens / G. Gayer / W. Koch
- 44     **Data management & quality assurance**  
G. Breitbach / J. Gandraß
- 46     **COSYNA communication: Outreach & inreach**  
C. Eschenbach



## Liebe COSYNA-Mitstreiter,

---

ein weiteres Jahr ist ins Land gegangen und es ist Zeit, wieder einmal Bilanz über die durchgeführten Arbeiten zu ziehen.

Nachdem das erste COSYNA-Jahr 2010 im Wesentlichen dem Aufbau von Messsystemen und der Anpassung von numerischen Modellen gewidmet war, wurden viele Systeme im letzten Jahr konsolidiert, einer Qualitätskontrolle unterzogen und in den prä-operationellen Betrieb überführt.

Das jedoch wirklich spannendste Ergebnis war, dass es uns gelungen ist, unser erstes COSYNA-Produkt seit Ende 2011 kontinuierlich im COSYNA-Portal zur Verfügung zu stellen ([www.coastlab.org](http://www.coastlab.org) → COSYNA Product: Currents).

An dieser Stelle für diejenigen von Ihnen, die noch nicht so mit der COSYNA-Terminologie vertraut sind: "COSYNA-Produkte sind automatisch erzeugte Datenfelder - kontinuierlich in Zeit und Raum -, die aus einer Kombination von automatischen Beobachtungen und Modelldaten hervorgehen (Daten-assimilation)."

Unser erstes Produkt ergibt sich aus kontinuierlichen Strömungsdaten von drei HF-Radarstationen, die in Modellergebnisse des GETM-Modells assimiliert werden. Entscheidende Vorteile sind, dass das Datenfeld über das Messfeld hinaus in die Deutsche Bucht hinein erweitert wird und Vorhersagen über die nächsten 6-12 Stunden möglich sind. Im Dezember 2011 bescheinigte uns eine internationale Begutachtung eine hohe wissenschaftliche Qualität der Arbeiten sowie das große Interesse an solchen Produkten und gab darüber hinaus Hinweise und Tipps, wie wir die Produkte in der Zukunft noch weiter verbessern können.

Zur Zeit sind die Kollegen daran, ein zweites COSYNA-Produkt fertig zustellen: Temperatur und Salzgehalt der Deutschen Bucht aus Satellitenbildern, FerryBox-Messungen und Modellen. Eine detaillierte Beschreibung der Produkte finden Sie in diesem Bericht.

Neben diesem Highlight wollen wir jedoch all die anderen Weiterentwicklungen, die 2011 erfolgreich durchgeführt wurden, nicht vergessen. Lassen Sie uns an dieser Stelle lediglich zwei Beispiele herausgreifen:

Neue stationäre FerryBox-Systeme wurden am Anleger in Cuxhaven und auf der Forschungsplattform FINO3 errichtet. FINO3 ist wegen der Küstenferne eine Herausforderung an die Wartungslogistik, liefert aber spannende Daten aus dem Offshore-Bereich, z. B. zur zukünftigen Bewertung des Einflusses von Windenergieanlagen auf das Nordsee-Ökosystem.

Glider wurden in das routinemäßige COSYNA-Programm aufgenommen. Es konnte gezeigt werden, dass sie auch in der Nordsee mit ihren hohen Strömungsgeschwindigkeiten geeignet sind, die dreidimensionale Struktur verschiedener Parameter near real-time zu erfassen - notwendig z.B. zur Interpretation der oberflächennahen FerryBox-Messungen und für die Entwicklung weiterer COSYNA-Produkte.

Insgesamt können wir feststellen, dass 2011 ein erfolgreiches COSYNA-Jahr war. Wir sind auf einem guten Weg, COSYNA zu einem in der Community anerkannten System zu machen. Wir wünschen uns allen ein weiteres erfolgreiches COSYNA-Jahr 2012.



*Dr. F. Schroeder C. Eschenbach*

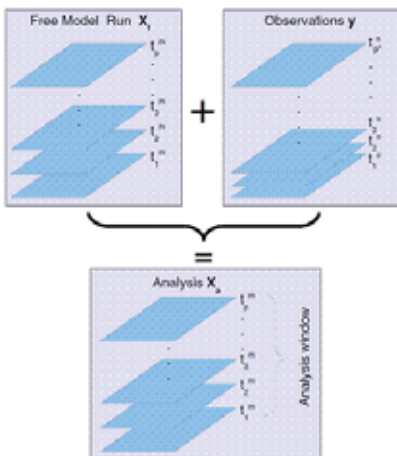
# COSYNA Product 1: Pre-operational surface current fields

E.V. Stanev / F. Ziemer / J. Schulz-Stellenfleth / J. Seemann / J. Staneva / K. Wahle

## Aims for 2011 and overall presentation of the Product 1

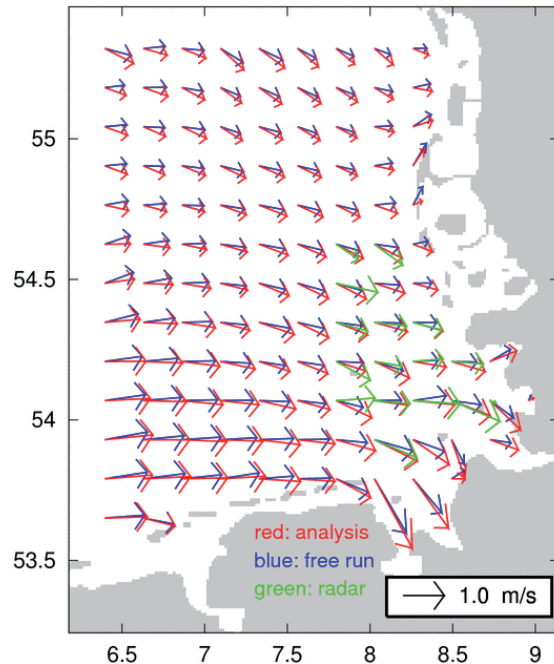
There were a couple of aims concerning COSYNA product developments in 2011. Some of these objectives were concerned with the optimisation of product 1, which is based on an integration of HF radar measurements with numerical model data to estimate high resolution surface current fields in the German Bight. Up to now 12 hrs hindcast surface current fields were computed using a three dimensional primitive equation model in combination with radial current components provided by radar stations located at Wangerooge, Büsum and Sylt. The analysis is based on a spatio-temporal interpolation method, which requires information on both measurement and model errors. The method is used for the pre-operational generation of respective hourly updated current field products, which are made available via the COSYNA data portal. In 2011 this system was further optimised both on the observation and the methodology side. These activities, which were also presented at the review meeting in late 2011 included

- continuation of set up of a sea surface current observatory
  - set up and tests of the network
  - start of the geophysical validation
  - start of the pre-operational phase
- product validation using FINO1 and FINO2 ADCP data
- inclusion of a 6 hour forecast capability in the offline system



**Figure 1:** Diagram illustrating the block-wise approach for the analysis of surface currents. Each layer represents one current field either from the model (top left), the HF radar (top right) or the analysis (bottom).

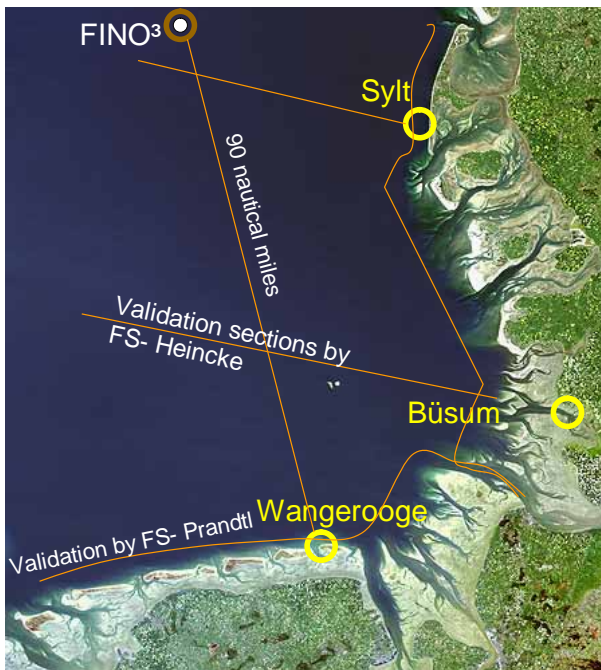
## Current Speed [m/s] Jan 12, 2012 10:00 UTC



**Figure 2:** Comparison of the surface current COSYNA Product 1 (red), the free run (blue) and the radar observations (green).

## Technical Developments in 2011: Continuation of set up of a sea surface current observatory

The observation area of the Wellen Radar High Frequency Radar (WERA) systems covers the South East part of the German Bight in the North Sea. The industrial use of this area and the big German ports together with the „KIEL-CANAL“ attract traffic in a way making this area to be a world wide hot spot in shipping. The water body within this area has open bounds to the North and the West, whereas two big rivers (Weser and Elbe) feed in their waters from the South and the East. The synoptic near real-time control of the complex ecology inside the COSYNA site is one of the leading objectives of this project. The main physical dynamic is forced by tidal forces overlaid by episodic storm events, which may double the tidal heave along the German coast. This task demands for a synoptic, near real-time survey of the current system what may be achieved by remote sensing technique. As innovative technique for area covering current observation the high frequency (HF) radar system is known since a couple of decades. Thus COSYNA integrates a network of three HF radar stations at well chosen positions on the coast of the German Bight (Figure 3).



**Figure 3:** Positions of the three COSYNA HF-radar stations. The positions have been chosen under the aspect of covering the important ship ways within the German Bight and to observe the water transport to and from the Wadden Sea. The southern station has been installed on the island Wangerooge (12.2 / 13.5 MHz). The stations in the East are located close to the harbour of Büsum and at the island Sylt (10.8 MHz both).

The basic physics in the HF remote sensing technique is to measure the amplitude and the phase of the signal that is back scattered from the structure at the sea surface caused by the gravity wave field. The HF signal is transmitted close to the sea surface to let it follow the curved earth surface even behind the horizon and its return can be measured even from long distances (up to about 100 nautical miles). The current detection is achieved by the detection of the frequency- or “Doppler”-shift between the transmitted and received electromagnetic signal. The setup of this system has been timed as follows:

1. Mounting and adapting all three coastal stations (until 3rd quart 2010),
2. Technical tests (until 3rd quart 2010),
3. Set up and tests of the network (until 4th quart 2010),
4. Geophysical validation (until 4th quart 2011) and
5. Pre-operational phase (2011 ff).

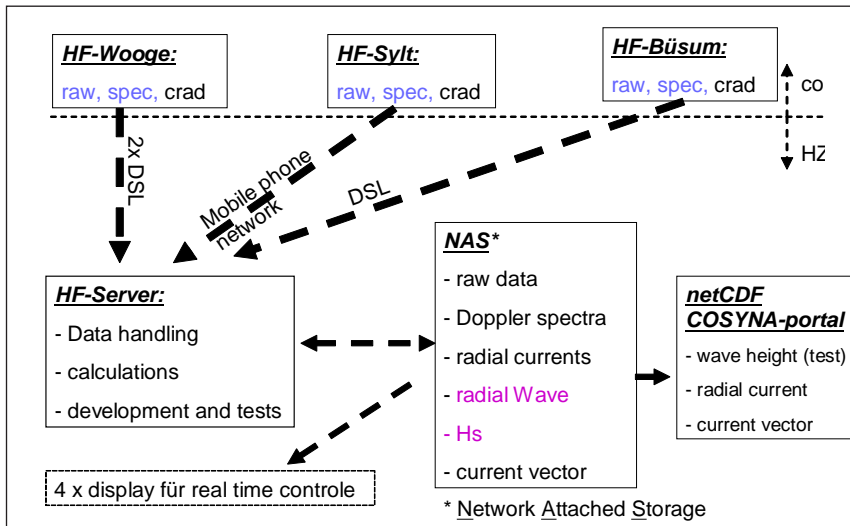
The first three phases have been started during the late summer in 2009 and were finished until the end of 2010.

The **mounting and adapting (1.)** was started during 2009 by mounting the station Wangerooge. This station was added to combine the two existing HF stations at the coast of Schleswig Holstein at Büsum and at Sylt, which have been used already for the Ocean Monitoring System - Project, that ended in 2009.

During phase 2. and 3. **“technical tests”** and **“the set up of the network”**, all stations have been linked with the HZG node in Geesthacht. For precise time synchronisation all three stations were equipped with GPS clocks. The network with the node in Geesthacht was completed within 2011.

Since January 2011 the **geophysical validation (4.)** phase has been conducted. And will be continued during the years 2012ff. This phase is to optimise the data handling, to verify the observation results and to improve their quality. That means as many as possible in-situ observations are acquired to produce a data set covering as many as possible collocation points in time and space, to check the accuracy of the HF technique. This has been prepared since 2009 by mounting and operating an Acoustic Doppler Current Profiler (ADCP) in combination with a Radar Current Doppler Profiler (RDCP) onboard the RV Heincke. The acoustic sensor provides vertical current profiles underneath the ship track and the side looking microwave radar produces horizontal profiles aside the ship track. As this ship can operate everywhere within the German Bight, current observations may be acquired covering a wide part of the area of interest (see: Figure 3). For the near coast area, during the year 2010 the RV Ludwig Prandtl was equipped with an ADCP that switches automatically in acquisition as soon the ship rides a regular speed within the area of interest (see: Figure 3). As soon the ship enters mobile telephone network the data acquired during the cruises are transferred to the HZG node. In addition time series of surface currents and waves acquired at fixed positions are used for the validation as well. These data acquisitions and the comparison with the HF results will be repeated not only during the validation phase, but during the entire pre-operational phase - until the end of 2014 - as well. In parallel to the validation phase the **pre-operational phase 5.** was started, that allows to test the “play together” of all components of the system.

## HF-node at HZG



**Figure 4:** Scheme of data flow towards the HF-node at HZG. At each of the three coastal stations the raw data are stored at hard discs. As first processing step the Doppler spectra for each resolution cell are calculated. From these spectra the radial components of the surface currents (crad) are deduced, quality controlled and quality flags are added to the data.

As within COSYNA the observation of any parameter is not a stand alone module, the acquired data are directly provided to become INPUT to numeric models after two first levels of quality control.

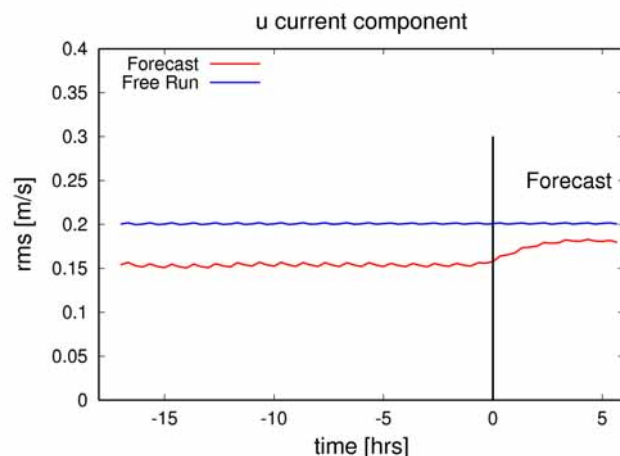
For further post processing and research on board each of the coastal stations all the raw data are stored on hard discs together with the Doppler spectra integrated over 10 minutes. To guarantee high storing security the content of the hard disks is mirrored to a second disk inside the station. This back up is deleted not before the successful storage of the raw data into the COSYNA data base at the laboratory at HZG in Geesthacht. In parallel to the storage of raw data the actual current components are processed in quasi “real time” directly after the acquisition onboard the coastal stations. While the raw data are continuously stored, the current components are transferred via telephone networks or internet to the node server at HZG. Together with control and QC parameters these are mainly the radial components of the current field as detected by each of the three WERA stations. At HZG they are quality checked again and combined to give 2-D ocean current vector maps three times per hour.

Radial components and 2-D maps are archived in a database and subsequently used in data assimilation with the numerical model system. COSYNA provides a web-based interface as downloadable NetCDF files to make the 2-D maps, as well as the model results available to the public.

## Program Developments in 2011

Concerning product 1 a couple of software updates were carried out both in the pre-operational system and the experimental off-line software.

- In the experimental off-line system the analysis window was extended to 24 hours. This window can be used for a 18 hours hindcast and a 6 hours forecast.
- A couple of additional data quality control checks were included in the pre-operational analysis scheme



**Figure 5:** Comparison of the free run and the analysis with radar measurement (*u* surface current component).



---

---

## Results (Highlights)

Concerning product 1 there were two highlights in 2011:

- Inclusion of a forecast capability in the offline system
- Positive review of the product by international experts

The forecast is based on the analysis of a 24 hours period including a 18 hours hindcast and a 6 hours forecast period. Figure 5. shows a respective statistics obtained by comparing the forecast with measurements taken afterwards. One can see that the method has a significant forecast skill for time scales, which are of practical relevance.

## Problems

There is still a problem with an insufficient number of ADCP data available for the validation of product 1. Some analysis could be performed with FINO1 and FINO3 data, but these data sets contain large gaps.

## Perspectives for 2012

There are ongoing activities concerning validation and optimisation of the product. In particular the forecast capability will be included in the pre-operational system.

## Publications

Stanev EV, Schulz-Stellenfleth J, Staneva J, Grayek S, Seemann J, Petersen W (2011): Coastal observing and forecasting system for the German Bight – estimates of hydrophysical states. *Ocean Science*, 7, 569-583.

# COSYNA Product 2: Hindcast/nowcast of SST and SSS in the German Bight

W. Petersen / E.V. Stanev / J. Staneva / J.Schulz-Stellenfleth / S. Grayek

## Aims for 2011

- implementation of an experimental assimilation scheme, which is able to integrate sea surface temperature (SST) and sea surface salinity (SSS) observations provided by satellites and/or FerryBox systems into a numerical model,
- statistical analysis and impact studies

## Program Developments in 2011

Concerning the integrated SST/SSS product the following software developments were carried out

- implementation of pre-processing software for both OSTIA SST and FerryBox data
- implementation of an optimal interpolation scheme for the assimilation of satellite SST and FerryBox SST and SSS data into the numerical model in FORTRAN90.
- implementation of analysis tools for statistical analysis and visualisation

## Results (Highlights)

The main highlights were the successful implementation of the experimental assimilation scheme and the application of the system for a one year hindcast.

The applied data assimilation method is based on an optimal interpolation approach using a Kalman filter with stationary background covariance matrices derived from a preliminary model run without data assimilation for the same period ("Free Run").

An assimilation step is performed every 24 h at 12:00 UTC. Data to be assimilated were taken from the route Cuxhaven-Immingham because this route provides the highest data availability for the German Bight region. Other routes like the one between Büsum and Helgoland or the Norway-Germany-England route are only available during specific periods and/or have a much longer revisit time and therefore were not considered. However, it has been proven in additional data assimilation experiments using these routes that the enhancement of the system by using these data is not to be neglected.

Illustrations are given below for the period from 1 March 2010 to 8 August 2010. We refer to the experiment in which the FerryBox data are assimilated as to the data assimilation (DA)

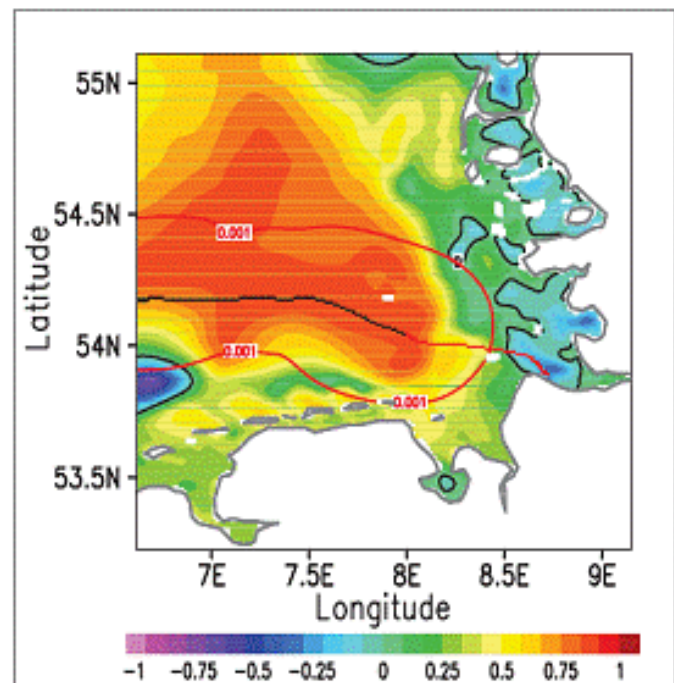
experiment. Validation of DA is performed against the MARNET Deutsche Bucht Data station (Stanev et al. 2011), where it is shown that misfits of SST and SSS in the free run are corrected almost completely in the DA run.

As the MARNET station is very close to the FerryBox track and one station only is not enough for a profound validation.

OSTIA data are used to estimate the skill defined as

$$\text{Skill} = \frac{\text{RMSE}^f - \text{RMSE}^{\text{DA}}}{\text{RMSE}^f} = 1 - \frac{\text{RMSE}^{\text{DA}}}{\text{RMSE}^f} \quad (1)$$

where  $\text{RMSE}^{\text{DA}}$  stands for the RMSE calculated from the output of the data assimilation run and  $\text{RMSE}^f$  for the RMSE calculated from the Free Run (the reference is OSTIA data). Figure 1 shows the skill for March 2010 (in the best case  $\text{RMSE}^f \gg \text{RMSE}^{\text{DA}}$ ,  $\text{skill}=1$ ). As expected, the assimilation is capable to improve the SST, mainly nearby the ship route. Because there are no global scale observations of SSS, the corresponding skill can not be easily established.



**Figure 1:** Skill of SST data assimilation (see eq. 1). The red line indicates the area beyond which the influence of FerryBox observations was reduced with a filter to avoid unrealistic SST fields.

---

The main results from these investigations were:

- FerryBox data have the capability to enhance SST hindcasts for the German Bight at least locally (up to +/- 40 km apart from the track). It was discussed in Stanev et al. (2011) that this is also true for SSS hindcasts.
- Application of the proposed methodology for real-time nowcasts and forecasts would require a continuous stream of quality checked near real-time data. This requires a permanent provision of data with minimum delay (near real-time) for a sufficiently long (e. g. half year period).
- Using OSTIA data presents one alternative to FerryBox data, as far as SST is concerned. Advantage of OSTIA data is spatial coverage; disadvantage is the coarse horizontal resolution, which can be overcome by the finer model resolution. However, at present there are no spatial SSS observations from satellite, which could complement FerryBox measurements. Therefore assimilation of FerryBox SSS has not an alternative.
- Proposed methodology can be used to develop new model-assisted measurement strategies and adaptive sampling by using a combination of various in-situ observing platforms, e.g., buoys, piles, FerryBoxes, gliders and AUVs.

## Problems

Concerning the development of the integrated SST/SSS product the situation is more complicated than for the first COSYNA product dealing with data assimilation of current measurements by HF radar. The main issues are:

- relatively long time gap between FerryBox data acquisition and availability for analysis
- first analyses have shown that the impact of FerryBox data in the analysis is confined to a relatively small region around the ferry track.

Furthermore FerryBox data have to be considered in combination with other satellite and in-situ data, which are used traditionally for SST and SSS observations. Additional analysis is required to decide how to do this in an optimal way.

## Perspectives for 2012

The work on the integrated SST/SSS product will be continued. Strategies to further integrate this product with depth profile measurements of gliders, which have become available in 2011, are currently under discussion. Furthermore the consequences following from a missing near real-time data access and the locally restricted impact of FerryBox data are assessed. This investigation may lead to a refinement of the original product definition concerning the capability to run it pre-operational. The validation of analysis results of SST with FerryBox and MARNET data and from other sources will be continued. In order to access FerryBox data in real-time from the Cuxhaven-Immingham route a satellite communication will be installed. In parallel, work will start on the implementation of an analysis scheme for depth profile information as, e.g., provided by glider systems.

## Publications

Grayek S, Staneva J, Schulz-Stellenfleth J, Stanev EV (2010): Use of FerryBox surface temperature and salinity measurements to improve model based state estimates for the German Bight. *Journal of Marine Systems*, 88, 45-59.  
Stanev EV, Schulz-Stellenfleth J, Staneva J, Grayek S, Seemann J, Petersen W (2011): Coastal observing and forecasting system for the German Bight – estimates of hydrophysical states. *Ocean Science*, 7, 569-583.

# FerryBox

W. Petersen

## Aims for 2011

- Continuous operation of three underway FerryBox systems in the North Sea aboard cargo ships and ferries respectively.
- Installation of a new stationary FerryBox at the off-shore observation platform FINO3
- Continuous operation of the stationary FerryBoxes in Cuxhaven and at FINO3
- Field campaigns aboard research vessels with the FerryBox system
- Installation of pCO<sub>2</sub> sensors aboard two FerryBoxes
- Testing/optimization of new sensors developments for unattended operation within FerryBox systems
- Improvements of automatic data quality assurance procedures for FerryBox data
- Scientific applications of FerryBox data

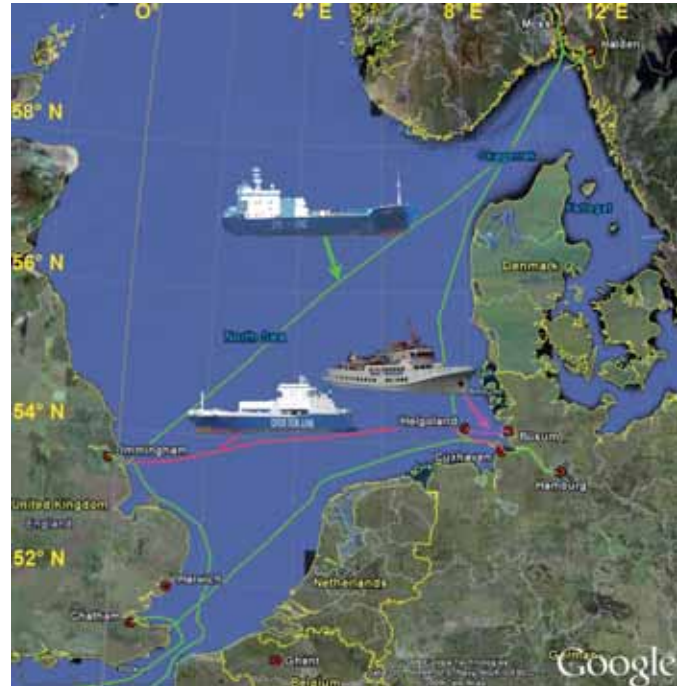
## Technical Developments in 2011

- At COSYNA campaigns aboard RV Heincke new sensors for high precision pH (PhD thesis S. Aßmann), PSICAM (point-source integrating cavity absorption meter) as well as nutrient sensors (SIA, HZG development C. Frank) were tested and optimized.
- A stationary FerryBox system at FINO3 was successfully installed and is operational since mid of June 2011.
- The operational observation of pCO<sub>2</sub> has been implemented aboard the vessels TorDania (route Cuxhaven - Immingham) and LysBris (route Norway - Germany - England - Spain)
- The FerryBox activities are imbedded within the EU project JERICO ([www.jerico-fp7.eu](http://www.jerico-fp7.eu)) started in May 2011.

## Results (Highlights)

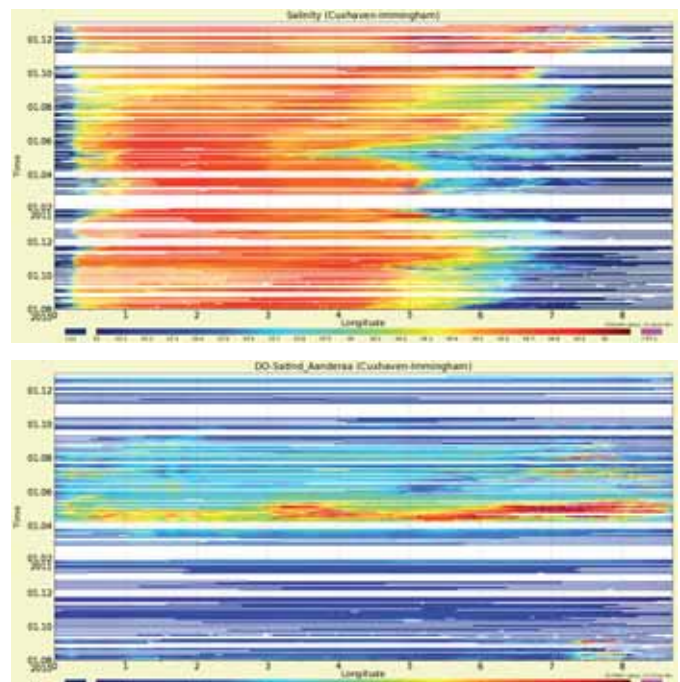
### Underway FerryBox systems

In 2011 all three underway FerryBox were operated the whole year. Figure 1 shows the operated lines in the North Sea.



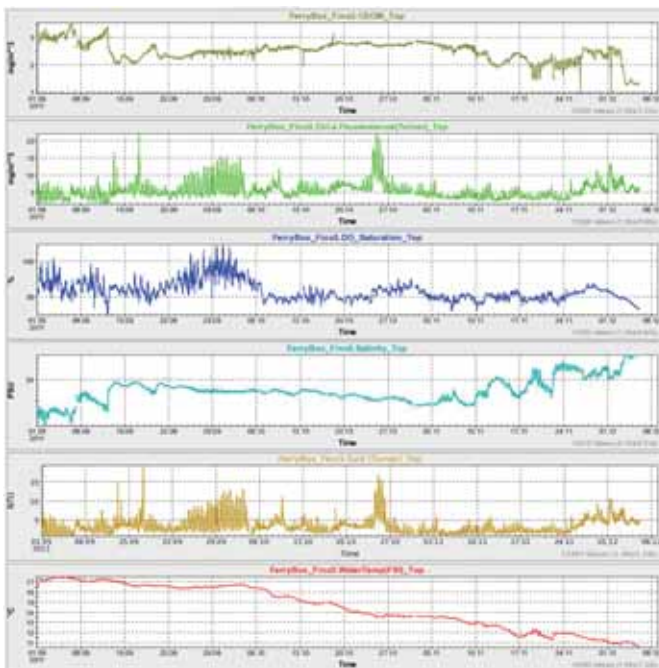
**Figure 1:** Operated routes in the North Sea in 2011

In 2011 the data availability was quite good on all three ships. As an example the pooled transect data (scatter plot) of the parameters salinity and oxygen saturation along the Immingham-Cuxhaven route are shown in Figure 2.



### FerryBox systems at fixed platforms

In addition to the FerryBox installation at the mouth of the Elbe River another FerryBox system has been successfully installed at the off-shore platform FINO3 mid 2011. First results are shown in Figure 3.

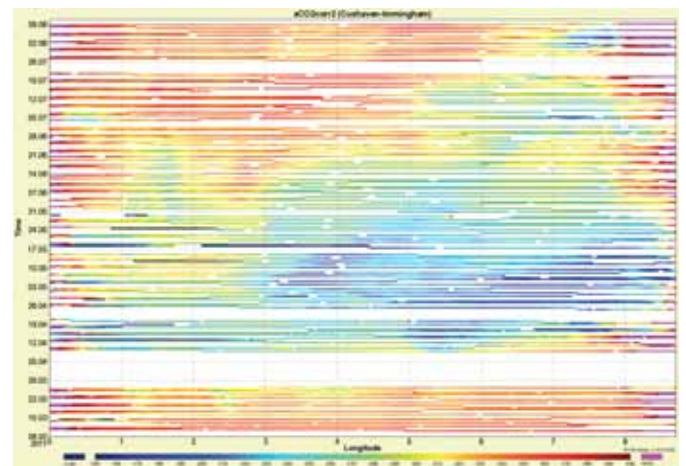


**Figure 3:** First data (surface water) from off-shore station FINO3: Data (CDOM, Chl-a fluorescence, oxygen saturation, salinity, turbidity and water temperature) from September – December 2011

The seawater is sampled at two water depths (surface and 15 m) by switching between two different inlets at hourly intervals. This allows detecting of stratification effects as well. The FerryBox measures temperature, salinity, chlorophyll-a fluorescence, turbidity, pH, and oxygen. In September a nutrient analyser ( $\text{NO}_3$ ,  $\text{NO}_2$ ,  $\text{PO}_4$ ,  $\text{SiO}_2$ ) has been installed as well. All data are averaged (10 min) and automatically quality checked and transferred to the COSYNA database in real-time via a satellite connection.

### Development and operation of new sensors

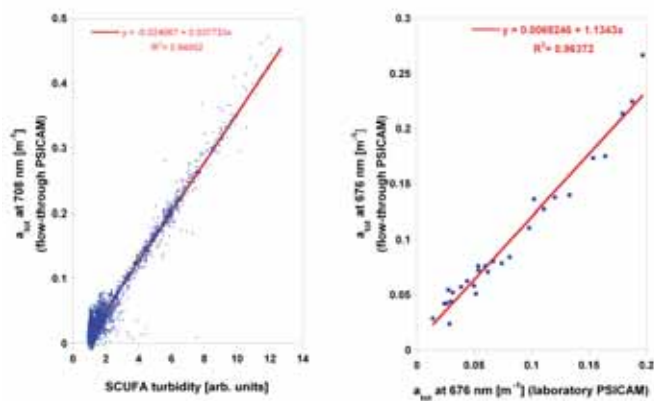
For the first time  $\text{pCO}_2$  sensors were installed aboard the vessels TorDania and LysBris. In Figure 4  $\text{pCO}_2$  data along the transect Immingham – Cuxhaven are shown. The data show a strong depletion between  $3^\circ\text{E}$  to  $8^\circ\text{E}$  from mid of April to mid of June which corresponds well to the observed algal blooms in that time period.



**Figure 4:** Pooled data of  $\text{pCO}_2$  along the transect from Immingham to Cuxhaven from March – August 2011

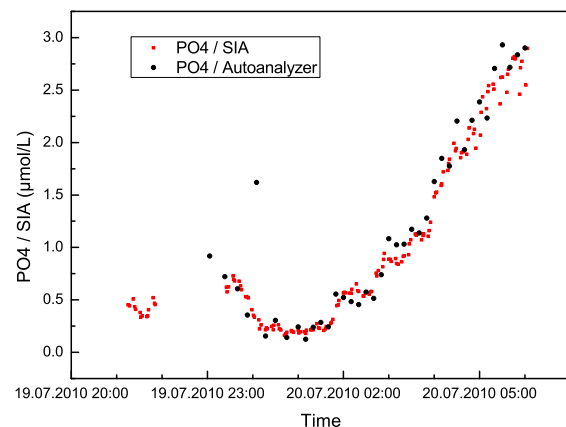
Within the scope of COSYNA three field campaigns with a FerryBox system aboard were carried out with the vessel RV Heincke (April, June and September) in the German Bight. These campaigns were also used for testing new sensors such as a high precision pH sensor (PhD S. Aßmann) and the PSICAM (point integrating cavity absorption meter). Figure 5 depicts some results of the PSICAM system. Main problem for an unattended long-term operation of a PSICAM in a FerryBox system is fouling on the surface of the cavity which dramatically influences the quality of the measurement due to strong changes of the reflectivity. Therefore, the system has to be cleaned periodically to remove substances such as Gelbstoff from the walls. The comparison of the absorption of chlorophyll-a (at 676 nm) between point measurements of the laboratory system with ideal reflectivity and the continuously operated flow-through system which was cleaned automatically at certain time intervals shows a quite good agreement during a 10 day cruise. Thus, the developed cleaning procedure seems to be a good way forward.

The comparison between absorption at 708 nm and turbidity measured by scattering (SCUFA instrument) shows that even the suspended matter concentration can be measured by such an instrument.



**Figure 5:** Field tests of PSICAM  
right panel: Chl-a absorption at 676 nm: flow-through vs. laboratory PSICAM  
left panel: Correlation of turbidity measurements by scattering (SCUFA) and absorption at 708 nm (flow-through PSICAM)

The tests of the new SIA system for the determination of phosphate showed very good results in comparison with lab analysis (Figure 6).



**Figure 6:** Comparison of o-PO<sub>4</sub> concentrations measured with the new SIA system and bottle samples analysed in the lab (autoanalyzer) RV Heincke, July 2010

In 2011 a first operational prototype of the SIA system has been built and will be operated on one of the FerryBoxes in 2012.

## Data management and quality assessment

In 2011 more sophisticated real time quality control measures were installed at the fixed platforms according to the recommendations of MyOcean and the EuroGOOS DATA-MEQ group for in-situ data near real-time quality control (RTQC). These measures include checking of housekeeping parameters such as flow rate, speed of the ship and statistical information (e.g. variance, frozen values etc.) in order to get high reliable data. From both stations quality controlled data are transferred in real-time every 10 min. These QA measures will be adapted and transferred to the underway systems as well in 2012.

## Problems

- The untended operation of the nutrient analysers is still a big issue. Aboard the vessel TorDania and LysBris nutrient analysers from the company Systea (Italy) are operated. These devices have still problems with long-term robustness and stability. The analysers operated on the fixed platforms (Cuxhaven, FINO3), which are measuring the nutrients sequentially, seem to be more reliable. However, these devices have not the necessary time resolution to be operated in underway systems.
- Even if the FerryBox works well on the station FINO3 the accessibility especially in the winter time may be a problem. A failure of the FerryBox computer due to a lightning stroke in December 2011 led to a long downtime of the FerryBox of more than two months. Only in February the computer could be replaced due to the limitation of available helicopter flights.
- The oldest FerryBox system aboard the TorDania has to be completely renewed after nearly 8 years of operation. Sensors can be taken over partly.
- The very limited personal capacity is still a big problem operating all FerryBox systems with the necessary care. Thus, for instance quality control is often lagging behind due to personnel bottlenecks. As well scientific evaluations and applications of the large amount of FerryBox data could be improved by employing additional PhD students and/or PostDocs.

---

## Perspectives for 2012

- First unattended operation of the new SIA PO<sub>4</sub> analyser prototype aboard one of the vessels
- Further development of the SIA system for nitrate and ammonia
- First unattended operation of the new developed high precise pH sensor aboard one of the FerryBoxes
- Real-time transfer of selected data via satellite (Imarsat) aboard TorDania for pre-operational data assimilation of temperature and salinity in numerical models
- Field test with new developed sampler for Gene probes (co-operation with AWI (K. Metfies))
- Enhancement of automated quality assessments to all FerryBox systems in order to provide quality checked data in real-time
- Intensified evaluation of FerryBox data with regards to oxygen, nutrients and pCO<sub>2</sub> (Postdoc from JERICO project)

## Publications

- Aiken CM, Petersen W, Schroeder F, Gehrung M, Ramirez von Holle PA (2011): Ship-of-Opportunity monitoring of the Chilean fjords using the pocket FerryBox. *Journal of Atmospheric and Oceanic Technology*, 28, 1338-1350.
- Petersen W, Schroeder F, Bockelmann F-D (2011): FerryBox – application of continuous water quality observations along transects in the North Sea. *Ocean Dynam.*, 61, 1616-7341.
- Stanev EV, Schulz-Stellenfleth J, Staneva J, Grayek S, Seemann J, Petersen W (2011): Coastal observing and forecasting system for the German Bight – estimates of hydrophysical states. *Ocean Science*, 7, 569-583.

# Wadden Sea poles

G. Flöser / K. Wirth / R. Riethmüller

## Aims for 2011

- Continuation of time series at both the Hörnum Deep and the Jade Bay stations from March to November
- Winter observations from November to March with a bottom-mounted system in the Hörnum Deep
- Solve problems with unstable pH sensor

## Technical Developments in 2011

A new type of automated multisensor probes replaced the old handheld systems to record the effects of pole maintenance on the sensor performance. They exactly mirror most of the pole sensors and thus record continuously the parameters over the entire maintenance period, allowing the determination of sensor drift and effects of biofouling to a much higher degree than the former system.

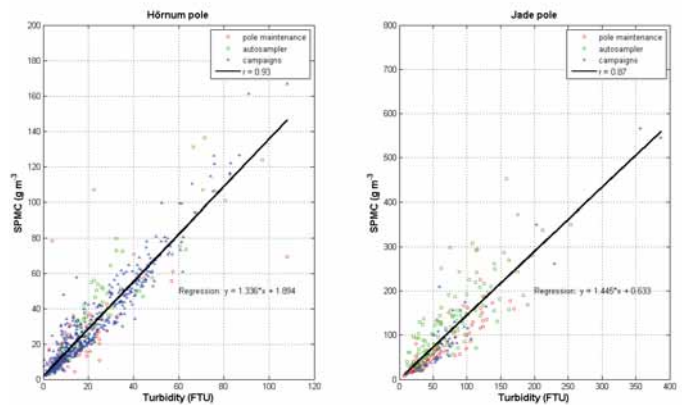
## Results (Highlights)

### Deriving suspended matter concentrations from optical turbidity and repeated water sampling

From the very beginning of optical backscatter (turbidity - Seapoint sensor, scatter at 880 nm) measurements, water samples have been taken in order to calibrate the turbidity data and convert them into suspended matter concentrations (SPMC). Because of short- and long-term variations in the optical properties of the suspended particles, variations in the relationship of sample concentration and optical turbidity can be expected. Samples were taken (1) during maintenance, (2) by means of an automatic water sampler and (3) onboard a nearby operating vessel. Meanwhile, the collection of sufficient samples allows statistically significant studies on the relationship of sample concentration and optical turbidity.

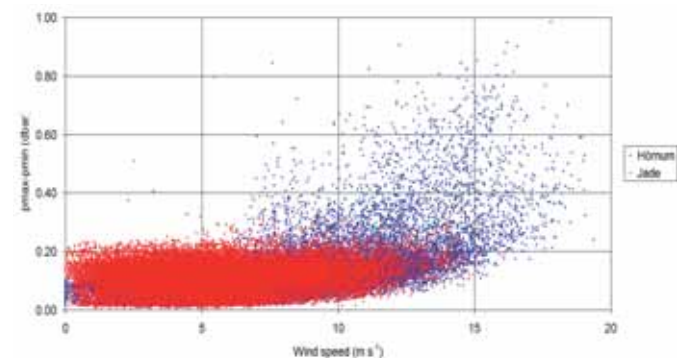
In Figure 1 the sample SPMCs are plotted versus the corresponding turbidities for the three types of samples. The data of different sampling types show a more or less comparable behaviour with a tendency of lower increase of the maintenance samples and were therefore pooled for the regressions. The correlation coefficient is  $0.925 \pm 0.025$  and  $0.867 \pm 0.050$  for the Hörnum and Jade data, respectively.

The higher scatter in the Jade data may be caused by additional variability due to ongoing dumping activities in the vicinity of the pole. The data show a nearly linear dependency with the slopes 1.336 and 1.445, resp., for the Hörnum and Jade pole. The thus calculated SPMC will be added as an extra parameter in the Coastlab data portal. The next step will be the correction of bio-fouling effects affecting the turbidity signals.



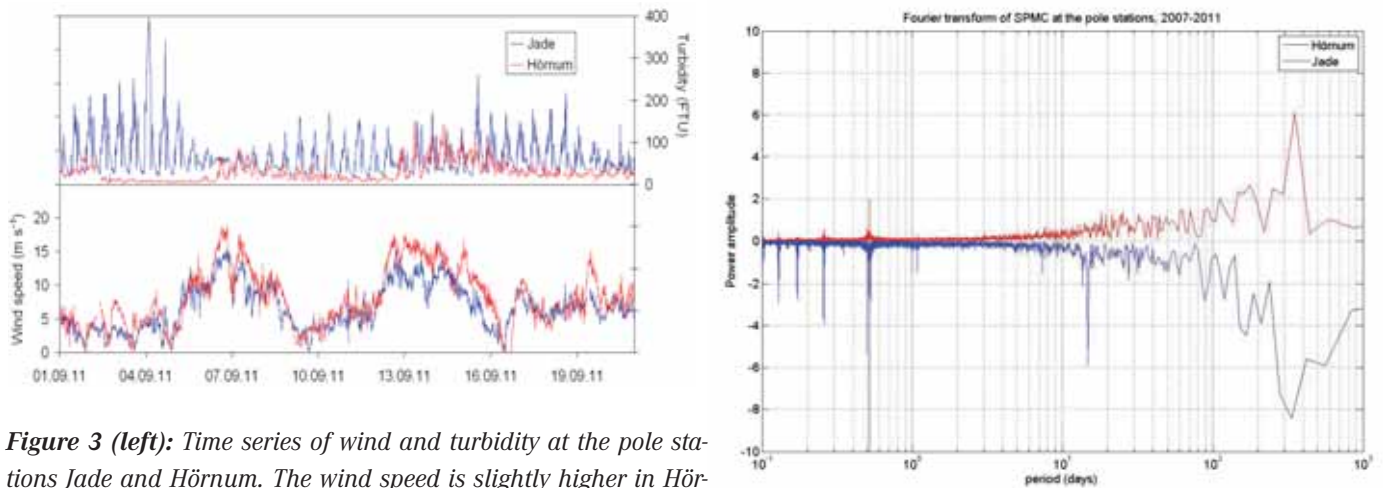
**Figure 1:** SPMC vs. turbidity for the pole stations Hörnum (left) and Jade (right) for water sampling during pole maintenance (red), by autosampler (green) and during ship campaigns near the poles (blue). The linear regression was done for all data from one pole position.

### Differences between Jade Bay and Hörnum Deep observations



**Figure 2:** Difference between maximum and minimum pressure during 10-min intervals vs. wind speed for the two pole stations in 2011. It is obvious that wind speed changes of 0-10 m s<sup>-1</sup> hardly cause any effect in the Jade station, but the Hörnum station reacts with an increase from < 0.2 to 0.8 dbar.





**Figure 3 (left):** Time series of wind and turbidity at the pole stations Jade and Hörnum. The wind speed is slightly higher in Hörnum. The turbidity shows reactions to the wind events on 6th and 12th September only in Hörnum, whereas the turbidity in Jade seems to follow just the spring-neap-cycle.

**(right):** Fourier transforms of SPMC time series (2008-2011) measured in Jade and Hörnum stations. Missing data were interpolated. The 0.52 (M2), 1.00 d (S2) and annual peaks at 365 d can clearly be identified. In the SPMC signal it is evident that all periodicities have a much stronger impact in the Jade station. Particularly the spring-neap-cycle is not visible in the Hörnum signal while it is strong in the Jade signal.

Preliminary analysis of the SPMC time series of the Hörnum Deep and Jade Bay stations reveal the differences of suspended matter dynamics between a very sheltered (long narrow inlet in the north of Jade Bay) and more open (Hörnum Deep) tidal inlet but also the differences in the relative location of the poles: central in the Hörnum Deep and close to the entrance (Jade Bay).

Generally, SPMC in the Jade Bay is about five times higher than in the Hörnum Deep (see Figure 3). At the same time, wind and waves do not influence the SPMC at the Jade pole (very low wind fetch) in contrast to the central Hörnum Bay where SPMC can increase by a factor of more than 5 in the course of a strong wind event (Figure 3). Westerly winds have no fetch in the Jade Bay, and thus no waves can build up (Figure 2). In the Hörnum Deep, winds from southwest have a direct impact on the pole location. This and the high tidal amplitude (~ 4 m) lead to a strong periodicity of the turbidity signal following the lunar (M2) and solar (O1, K1 as well as the spring-neap cycles [Figure 3b]). In the Hörnum Deep, the periodicities are much less pronounced which leads to the assumption that the (aperiodic) wind has a stronger influence here.

## Problems

The pH sensor still shows instabilities that are not fully understood. A planned field campaign to better understand this behaviour had to be abandoned in 2011 because of bad weather.

## Perspectives for 2012

- A field campaign shall help solve the problems with the pH sensor.
- The scales of spatial representativeness of the pole observations along and across the tidal channel will be analysed during a dedicated field campaign.
- Operation of a new pole station in co-operation with Hamburg Port Authority close to the Elbe mouth
- Development of processing tool for correction of biofouling

## Publications

- Onken R, Garbe H, Schröder S, Janik M (2010): A new instrument for sediment temperature measurements. *Journal of Marine Science and Technology*, 15, 4, 427. doi: 10.1007/s00773-010-0096-82
- Flöser G, Burchard H, Riethmüller R (2011): Observational evidence for estuarine circulation in the German Wadden Sea, *Continental Shelf Research*, 31, 1633-1639.

# X-Band observation in the lateral ocean

F. Ziemer / J. Seemann

## Aims

The high potential of waves and currents to silt up or even to destroy instruments or their moorings challenges to observe littoral processes by remote observations techniques. Here we report on first applications of shore based Doppler radar to observe the energy dissipation of waves propagating towards the shore along a profile of 1000 m and longer.

## Technical progress

The used marine X-band radar has been converted into a coherent on receive system (Braun, Ziemer et al., 2008). The potential of this radar is to detect small scaled features, which are produced by inhomogenities in the bathymetry or by stationary current shears. Due to the high resolution in time and space the radar acquires the radial surface velocities locally along a radial line as shown in the diagrams in Figure 1. Sending out about 1000 pulses each second provides

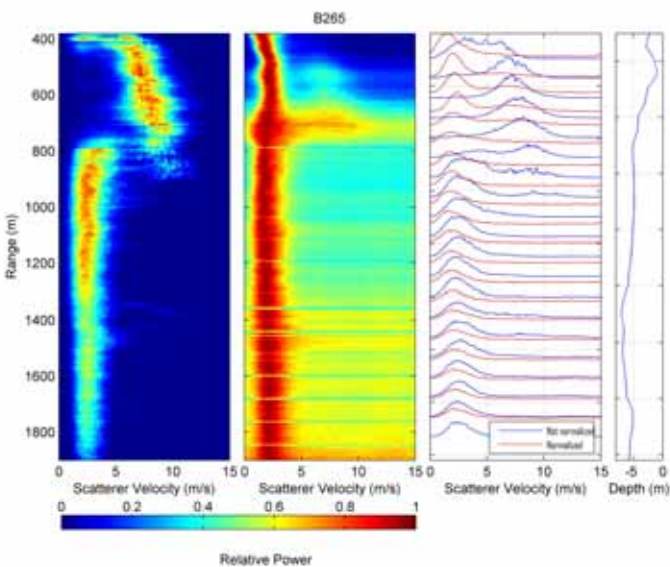
every half second a significant Doppler spectrum to compose times series of surface motions. In principal each spectrum is classified in one of the following categories: 1. current and / or orbital motion, 2. breaking events at the wave crest and 3. noise (low power) from the shadowed surface elements. The categories 1. and 2. can be related to wave motions and are clearly to be identified by the position of the spectral peak. The Doppler information is either extracted directly from the peak position or calculated from the spectral moments, whereas the noise has no clear maximum and the speed value for the given time step and the given range bin is set to be "0".

## Results and perspective

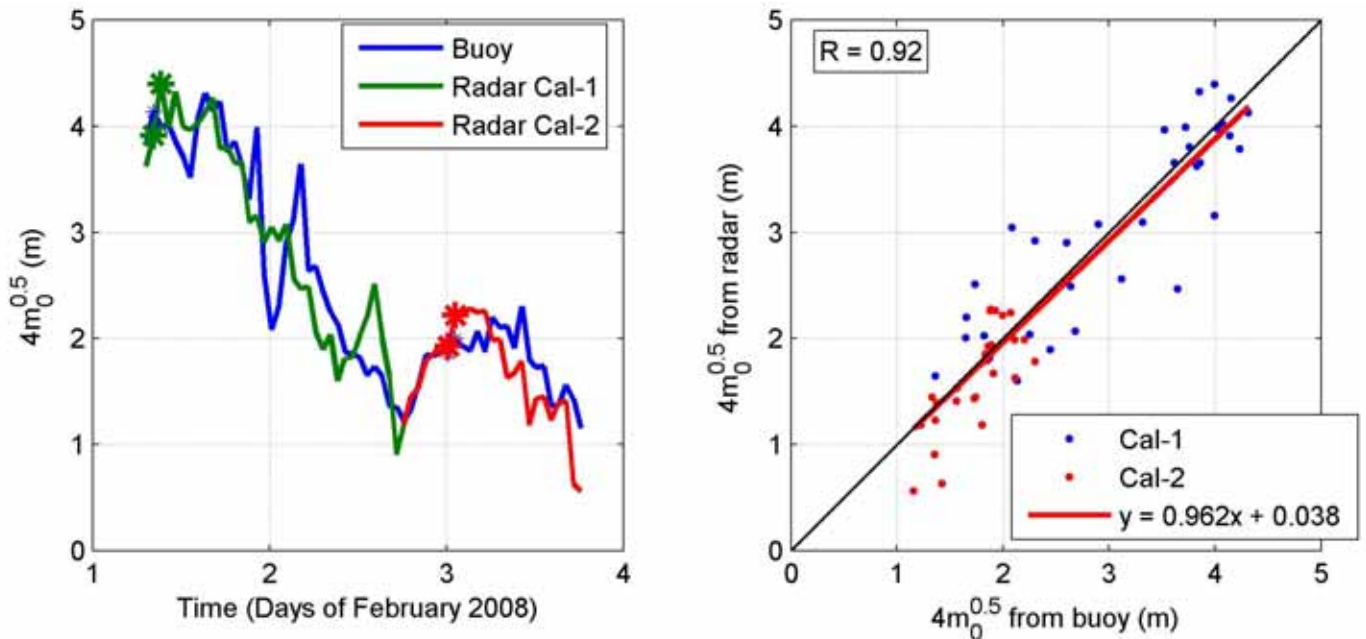
The results attained by Doppler measurements are displayed in a two dimensional graph as "range - Doppler map" (see Figure 1). The individual spectra, for each of in total 250 range bins, have been generated by integrating 500 successive radar pulses to complex time series with the duration of 0.5 s and Fourier transformed. For the range - Doppler maps the spectra have been averaged over 8 minutes.

On the left for in total 250 radial bins the Doppler spectra are displayed on top of each the other. Thus the vertical axis gives the distance to the antenna that has been mounted in 400 m distance to the shore. The variance in radar cross section is displayed by the colour code; see the bar for relative power.

To demonstrate the separation of speeds due to orbital wave movement from speed detected over the crests of breaker events for about 20 chosen range bins a subset of Doppler spectra are shown in the next right row. Most of them show a single peak with less than 3 m/s. These speeds are related to the surface motions by wave driven orbital speeds. Spectra acquired at distances closer then 800 m show a second peak between 5 m/s and 10 m/s. These values are too high to be related with wave orbital speeds. From the graph it becomes evident that the higher Doppler speeds occur in those distances where the shore parallel sand bare is located (see: the depth profile at the right extracted from sounding of the BSH).



**Figure 1:** Result of radar measurements acquired in February 2009. **Left:** Radial Doppler speed (horizontal axis) and variance of radar cross section (color code) along the distance to radar (vertical axes) in all 250 radar cells. The color code gives the variance in cross section normalized within the individual range bins (left) and normalized for the entire data set (right). **Next row right:** Doppler spectra from a chosen subset of data. **At the right:** Bathymetry along the radar section sounded by BSH half a year before the Radar acquisition during summer 2008.



**Figure 2:** Comparison of the significant parameter describing the wave height deduced with the same algorithm from buoy and from radar observations. The buoy was moored about 5 miles away but at the same water depth as the radar footprint

The next step is the evaluation of the local wave energy spectra. For each of the radial radar bins we first construct time series with a step width  $\Delta t=0.5s$  of surface movements deduced from the Doppler observations. We cut out time steps at these locations, where we identified breakers and fill these time steps with zeros. From the shadowed parts of the sea surface the signal strength is reduced below the noise level and filled with zeros as well. The remaining time steps are composed to construct an intermittent series of information on the back and forth movement of the scattering facets. This series has been Fourier transformed. For a first approach we define a transfer function between the heave spectra and the displacement spectra by using spectra from a close by

wave rider. This transfer function is to compensate effects of the interrupted time series and the non circular shape of the orbital movements over the shallow water. This kind of transfer function has been used successfully for other radar systems.

Wave breaking has a minimum in 1300 m from the antenna. Thus we choose that distance for a first trial to apply the method described above. The three day time series of significant wave height acquired by radar and by buoy are at the left in Figure 2. Both, time series and the scatter diagram show that the results deviated within a neglectable bandwidth from each other. The scatter index ( $R=0.92$ ) proofs the good correlation between the in-situ system and the radar.

# Remote sensing

R. Röttgers/H. Krasemann/W. Schönfeld/K. Heymann

## Aims for 2011

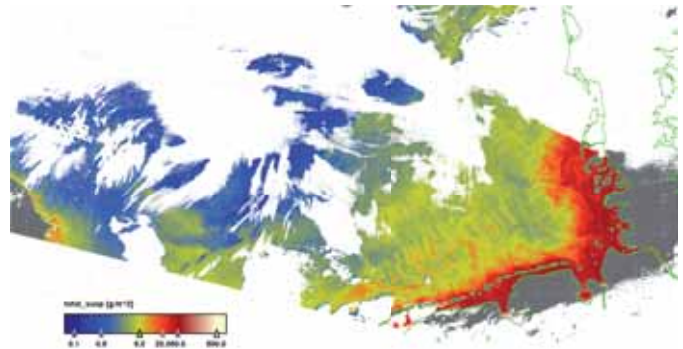
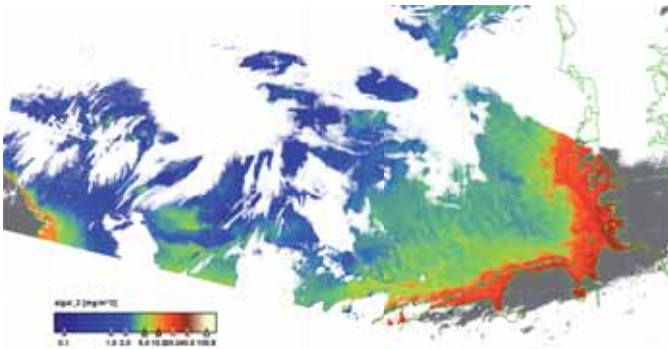
- Advanced algorithms for optical remote sensing, which include temperature and salinity effects on pure water optical properties
- Adaptation and validation of regional algorithms for coastal waters on the global scale
- Measurements of optical properties in the Lena River Mouth
- Measurements of optical properties in the German Bight, and inland waters (Lake Schaalsee, Zingster Bodden)

## Technical Developments

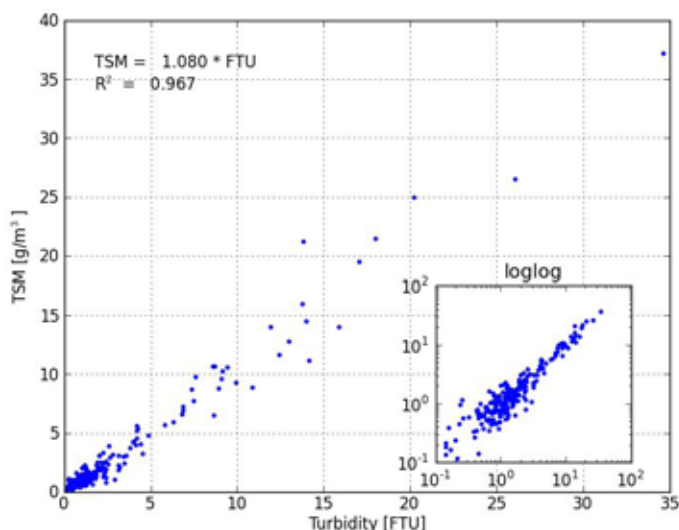
- Including a holographic camera (LISST-HOLO) in the in-situ instrument package
- Development of a Python-based operating software for the PSICAM
- Development and provision of Web-GIS maps for the COSYNA-portal
- Pre-operational provision of satellite-based chlorophyll and suspended matter concentration data in NetCDF for the COSYNA-portal

## Results

- Model of pure water optical properties dependence on temperature and salinity
- Enlarged data set of North Sea water inherent and apparent optical properties
- Cross validation of optical properties (NIR-absorption, scattering, back-scattering) and concentration of suspended matter. The results are used to improve current methods for the determination of SPM, and cross-validate different instrumentation.
- Implementation of an improved atmospheric correction in the standard MERIS processor



**Figure 1:** Examples for chlorophyll and suspended matter concentration calculated by the newest MERIS Case 2 algorithm (10 March 2012).



**Figure 2:** Total suspended matter (TSM) concentration versus turbidity measured by a Seapoint turbidity sensor

### Supporting externally funded projects

ESA-WaterRadiance project  
 ESA-CoastColour project  
 ESA-Climate Change Initiative Ocean Colour  
 EU-PROTOOL project  
 DLR-ENMAP project  
 WiMo, funded by government of Niedersachsen

### Problems

- The angular problem in the atmospheric correction for MERIS data is still waiting for a conclusive solution.

### Perspectives for 2012

- Measurements of bio-optical variables in the Laptev Sea (Lena Delta)
- Development and validation of algorithms for algal-group identification from remote-sensing data

### Publications

- Berg MG, Mills MM, Long MC, Bellerby R, Strass V, Savoye N, Röttgers R, Croot PL, Webb A, Arrigo KR (2011): Variation in particulate C and N isotope composition following iron fertilization in two successive phytoplankton communities in the Southern Ocean. *Global Biogeochemical Cycles*, 25, B3013, 16 pp.
- Taylor BB, Torrecilla E, Bernhardt A, Taylor MH, Peeken I, Röttgers R, Piera J, Bracher A (2011): Bio-optical provinces in the eastern Atlantic Ocean and their biogeographical relevance. *Biogeosciences*, 8, 3609-3629.
- Röttgers R, Koch BP (2011): Indications for a ubiquitous dissolved pigment degradation product in subsurface waters of the global ocean. *Biogeosciences Discussions*, 8, 10697-10724.
- Röttgers R, Gehnke S (2012): Measurement of light absorption by aquatic particles: improvement of the quantitative filter technique by use of an integrating sphere approach. *Applied Optics*, 51, 1336-1351.
- Tilstone GH, Peters SWM, van der Woerd HJ, Eleveld MA, Ruddick K, Schonfeld W, Krasemann H, Martinez-Vicente V, Blondeau-Patissier D, Röttgers R, Sorensen K, Jorgensen PV, Shutler JD (2012): Variability in specific-absorption properties and their use in a semi-analytical ocean colour algorithm for MERIS in North Sea and Western English Channel Coastal Waters. *Remote Sensing of Environment*, 118, 320-338.

# Gliders

L. Merckelbach / A. Werner / R. Kopetzky / B. Peters

---

## Aims for 2011

Having set up the main infrastructure to ballast and prepare gliders (glider lab) and to control them via satellite communications in 2010, the aims for 2011 were to perform a number of deployments in order to

- determine how well gliders fly in energetic tidal coastal waters such as the German Bight,
- develop a strategy to deal with the high intensity of shipping in the German Bight,
- explore various logistic solutions to deploy and recover gliders.

## Technical Developments in 2011

Three glider missions, operating in the area northwest of Helgoland, were scheduled and executed successfully:

- 2 weeks with glider Amadeus in February 2011, deployed and recovered near Helgoland using small boats of AWI, Helgoland,
- 4 weeks with gliders Amadeus and Sebastian in June 2011, deployed and recovered using small boats of AWI, Helgoland,
- 4 weeks with gliders Amadeus and Sebastian in September 2011, deployed from the research vessels Heincke and Ludwig Prandtl, respectively, and recovered near Helgoland with Ludwig Prandtl.

In relation to the risk on collision with ships, the German authority responsible for shipping (Wasser- und Schifffahrtsamt, WSA) has declared that glider operations in German waters is in general forbidden. However, an exemption can be applied for specific missions with a limited duration. One of the conditions is that the Seewarndienst (Navigation Traffic Control) is provided with 12-hour forecasts of glider positions. A system has been developed based on the GETM current model and a model of glider dynamics and (robotic) behaviour to forecast glider trajectories. This information, condensed to the coordinates of a bounding box around the glider's trajectory, are sent automatically by email during the missions. This information is then relayed to ships via Navtex by the Seewarndienst.

Furthermore, tools have been developed for near real-time glider data transfer into the COSYNA database.

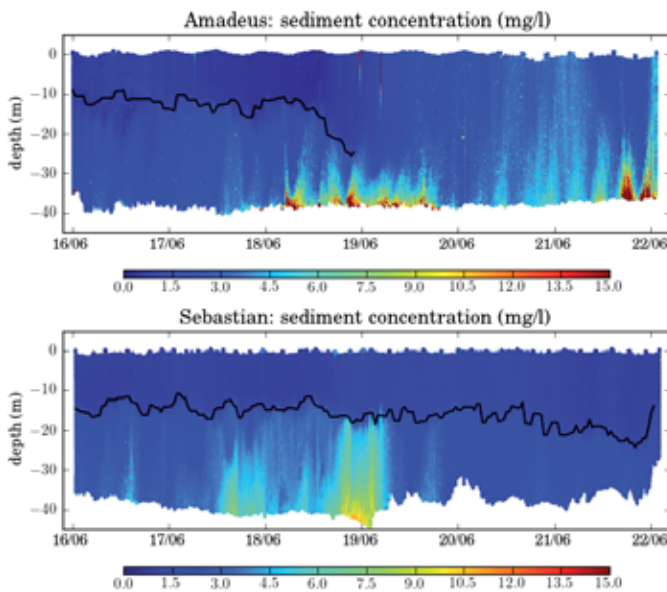
## Results (Highlights)

Although tidal currents can be larger than the glider speed, it was shown that gliders can be controlled well and that the drift due to the currents is of the order of 3-5 km. The system to generate automated glider position forecasts has evolved to a working system that Seewarndienst is satisfied with. However, every now and then, the system breaks down because of unexpected delivery failures of GETM model data.

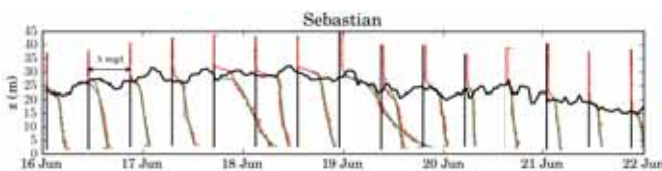
In terms of logistics, the research vessel Ludwig Prandtl has demonstrated to be a most flexible platform, but she is subject to availability. The island of Helgoland is an excellent base to work from, however, transport to and from the island is time consuming and cumbersome with heavy gear. The short time window required for deployments allows the research vessel Heincke to be suitable for deployments, with the advantage that a glider can be taken far off-shore. Due to time constraints a glider recovery is not feasible using the RV Heincke.

Water currents, derived from glider data, have been compared with currents predicted by the GETM model (free run). Preliminary results indicate that the magnitude of the north-component of the currents is usually noticeable smaller for the GETM model than for the glider data. A dedicated glider experiment of two weeks is scheduled for February 2012 to compare glider derived currents with HF-radar surface currents.

During the June mission, both gliders observed sediment resuspension events during a summer storm. The patterns observed by both gliders are quite different despite a mutual distance of only 70 km, see Figure 1. An analysis shows that suspended sediment is confined to the layer below the pycnocline (indicated by the black line in Figure 1), and vertical profiles are well approximated by Rouse profiles, see Figure 2.



**Figure 1:** Suspended sediment concentrations observed during a summer storm. The black line indicates the location of the summer pycnocline.



**Figure 2:** Rouse profiles (red) for glider Sebastian, where  $z$  is the height above the bed and the black curve represents the pycnocline.

### Problems

Despite the challenging conditions of the German Bight few problems have turned up during the missions. The recovery of glider Sebastian at the end of the June mission was complicated as all methods of communications failed due to misjudged battery capacity. The September mission of glider Sebastian had to be ended prematurely due to an apparent disconnected battery pack, which, unfortunately, pre-mission tests cannot reveal.

### Perspectives for 2012

For the period of mid April to end of June a continuous glider mission is foreseen, where the use of the two gliders will be alternated. The aim is that the development of the temperature stratification can be monitored as well as the growth of phytoplankton. A second long term mission is planned for August and September.

### Publications

- Merckelbach LM, Onken R, Riethmuller R (2012): Sediment resuspension analysis from combined glider and ScanFish observations in the German Bight, Ocean Sciences Meeting, 20-24 February 2012, Salt Lake City, Utah, USA. (Poster presentation)
- Merckelbach LM (2011): On the risk of glider-ship collisions. Submitted to Journal of Marine Science and Technology (under review).

# SCANFISH

R. Riethmüller / H. Thomas / H. Rinck / R. Kopetzky / R. Hofmeister /  
M. Schartau / K. Wirtz

## Aims for 2011

- Adding further hydrographical situations in the inner German Bight from RV Heincke surveys
- Adding observations to the glider campaigns in June and September 2011
- Routine use of the “Sampling-Calibration-Profiler” (SCP) to derive water constituent parameters from optical signals
- Test and implementation of SCP onboard RV Heincke
- First version of GUI-based software for delayed processing and QC by the technical staff
- Generation of QC data sets for selected campaigns and data import into COSYNA data portal

## Technical Developments in 2011

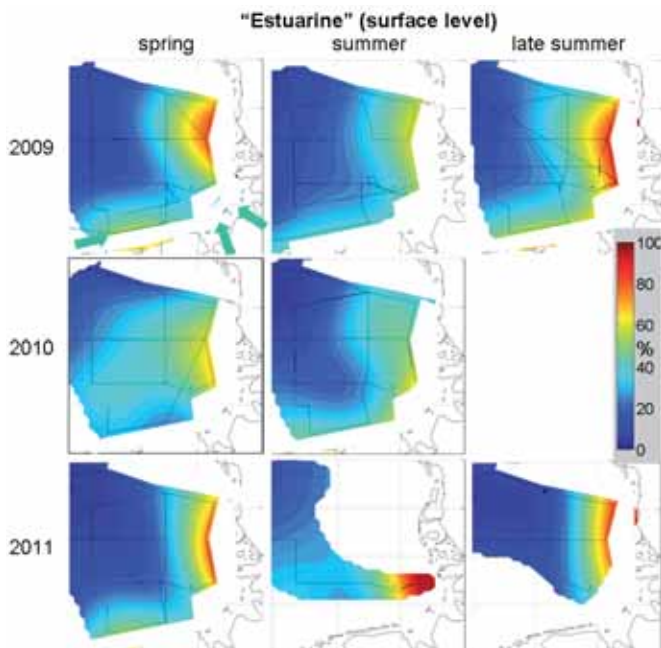
- No significant developments in 2011

## Results (Highlights)

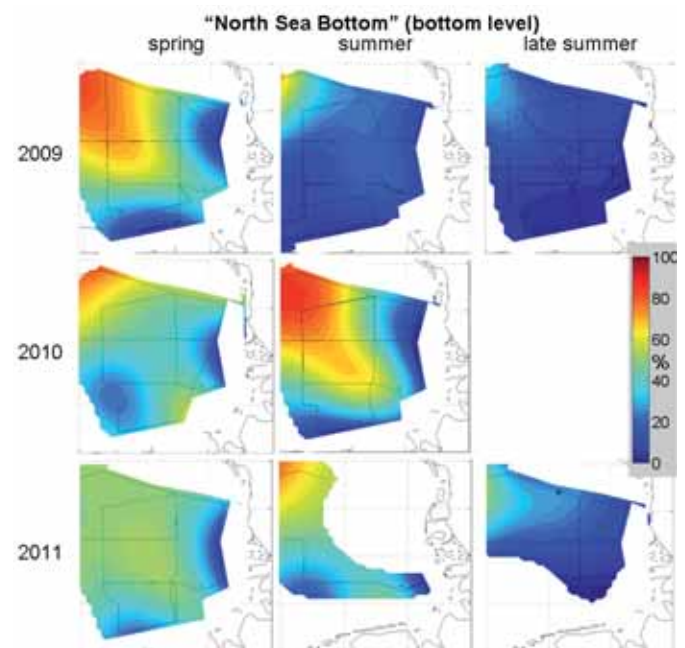
Water mass compositions were derived from linear mixing of three water bodies (Estuarine-EST, North Sea Surface-NSS and North Sea Bottom-NSB) following Becker et al. (1983) (see also Progress Report 2010). To show the spatial distribution more

clearly the data were interpolated applying objective analysis for different water column levels. At all situations observed so far, EST waters are confined mainly to the North Frisian coast indicating that waters from Elbe river are directly transported towards North and do not follow the glacial Elbe valley South of Heligoland (Fig. 1).

In contrast, NSB waters seem to intrude into the innermost German Bight just along this valley, especially during situations of high stratification in summer (Fig. 2) demonstrating the significant bathymetric influence on the residual circulation. The regularly observed distinct fluorescence and oxygen maxima at the pycnocline stimulated the formulation of algal growth and zooplankton grazing processes in response to the oceanographic conditions. One-dimensional simulation results of the Model for Adaptive Ecosystems in Coastal Seas (MAECS), shown in Fig. 3 in qualitative comparison with ScanFish observations, reveal how adaptive stoichiometric changes such as nitrogen-to-carbon ratios in diatoms control their buoyancy and sinking and in combination with photoacclimatisation may explain the observed deep chlorophyll maxima.

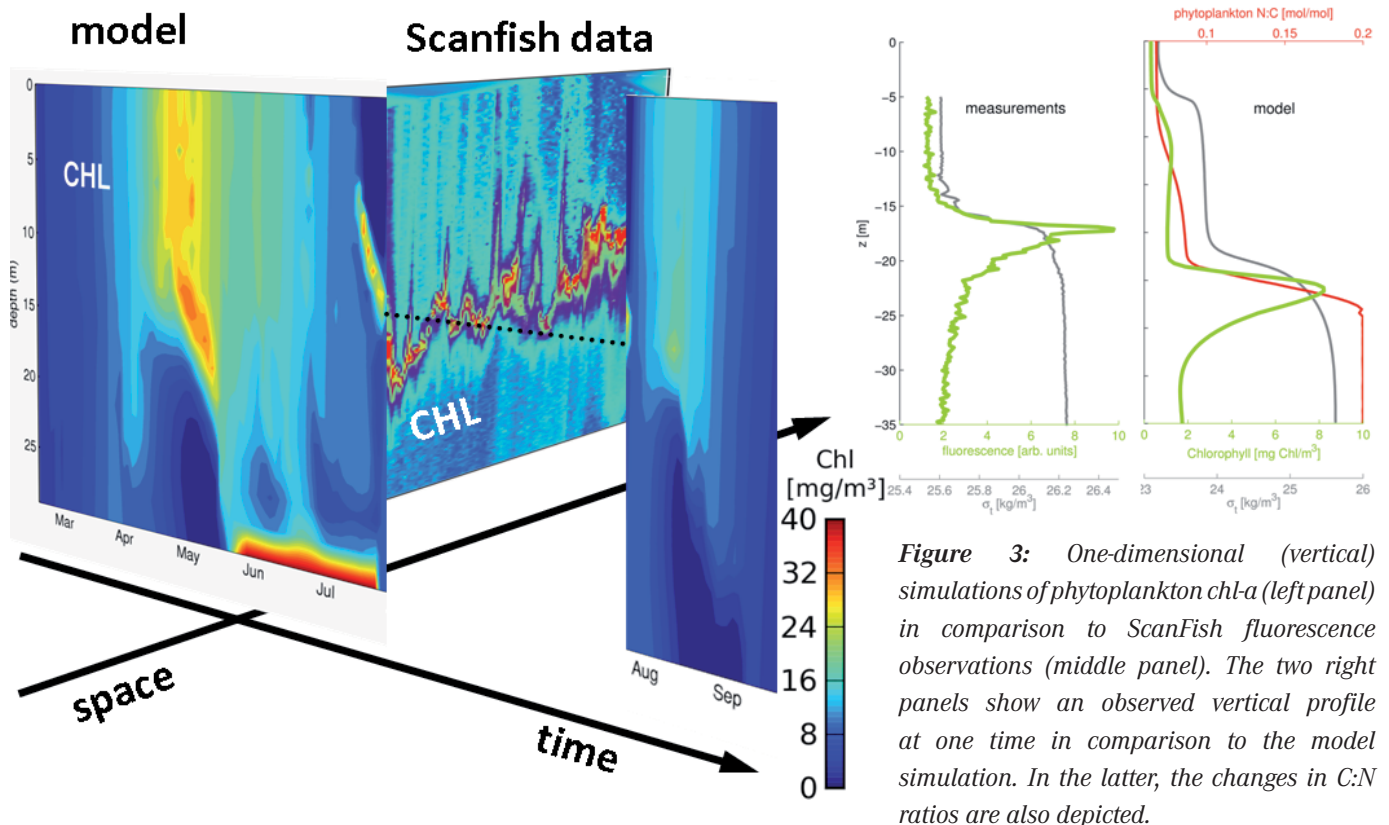


**Figure 1:** Horizontal distribution of EST waters in the upper 6 m of the water column (“surface”). The observations were taken at the transects (black lines) and spatially interpolated using objective interpolation.



**Figure 2:** Horizontal distribution of NSB waters in the lower 6 m of the water column (“bottom”). The observations were taken at the transects (black lines) and spatially interpolated using objective interpolation.





**Figure 3:** One-dimensional (vertical) simulations of phytoplankton chl-a (left panel) in comparison to ScanFish fluorescence observations (middle panel). The two right panels show an observed vertical profile at one time in comparison to the model simulation. In the latter, the changes in C:N ratios are also depicted.

## Problems

- Ongoing problems with the winch lead to abortion of measurements in the midst of two campaigns.
- Feedback corrections of ScanFish flights too retarded, which leads to bumpy flights and at rough sea to flights across the water surface.
- Faulty control box of SCP prevented operations onboard RV Heincke and prevented sample calibrations.
- Completion of the software for the delayed mode processing and data preparation for the COSYNA data portal was delayed.

## Perspectives for 2012

- Mechanical and electronical upgrades of the ScanFish platform to improve rigidity and flight behaviour
- Winter survey with RV Heincke in February
- Generation of QC data sets for selected campaigns
- Test of real-time processing with pre-operational filters
- Time lag corrections of temperature and conductivity sensors

- Routine intercalibration operations with other COSYNA platforms (FerryBox, profiler, glider)
- Joint analysis of water body stratification and vertical distributions of suspended sediments using both glider and ScanFish data

## Publications

Schartau M, Riethmueller R, Floeser G, Doerffer R, Hofmeister R, Wirtz K, Petersen W, Colijn F (2012): Prospects and limitations of synthesizing data from a coastal observatory for analyses of physical- and biological processes in the German Bight and Wadden Sea. In preparation for Journal of Sea Research.

## References

Becker GA, Fiusa AFG, James ID (1983): Water Mass Analysis in the German Bight during MARSSEN, Phase I. J. Geop. Res., 14 (88) 9865-9870.

# RV Ludwig Prandtl measuring systems

G. Flöser / M. Heineke

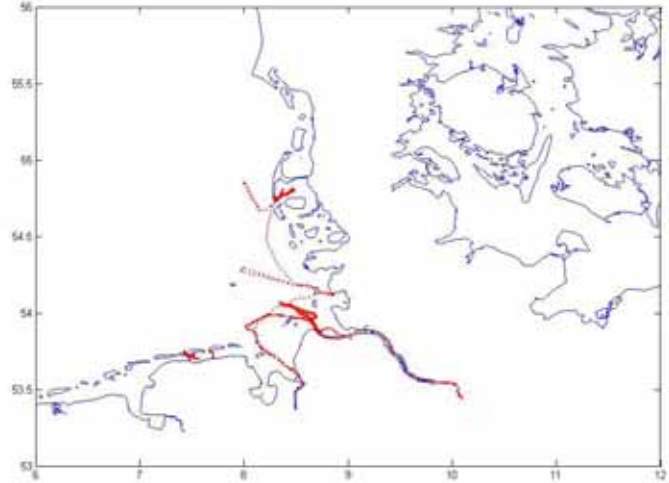
## General situation in 2011

The research vessel Ludwig Prandtl operates mostly in the Wadden Sea waters, Elbe estuary, and coastal waters between the mainland and Helgoland. It is used for measuring campaigns of usually 1-2 weeks or once or twice a year for assembling / disassembling of the pole stations. Thus it can serve as a moving instrument platform in COSYNA, albeit not for regular cruises.

Thus the ship has been equipped with meteorological sensors, and along with the navigation and ADCP data they are permanently transmitted by mobile phone connection to the HZG database. The advantage is that for every sampling procedure on board, those datasets are available, and the data may be used for the validation of HF radar measurements (see below) or for hydrodynamic modelling of the German Bight. The obvious limitations lie in the episodic nature of ship campaigns. In Figure 1 all locations of the 2011 cruises are given.

The meteorological sensors include air temperature and pressure, solar radiation, relative humidity, wind speed and -direction. Navigation parameters are heading, speed over ground, pitch and roll, and the water depth measured by an echosounder.

The system DES (Datenerfassungssystem, data retrieving system) is operated automatically to a high degree. Three statuses are defined: rest, transfer and measurement (L/U/M). The transition between rest and transfer is defined by a limiting speed of 1.5 m s<sup>-1</sup> (with a time delay of 5 min). During status "rest" the ADCP is switched off. For a ship campaign, information about the campaign must be typed into the system, and the DES switches into "measurement" status. The end of the campaign also has to be defined manually. The ship's data are transferred hourly by mobile phone connection to HZG and fed into the COSYNA database [surveydata.hzg.de](http://surveydata.hzg.de).



**Figure 1:** All locations of the RV Ludwig Prandtl in 2011. The foci Hörnum Bight, Cuxhaven and the campaign location Spiekeroog can clearly be identified.

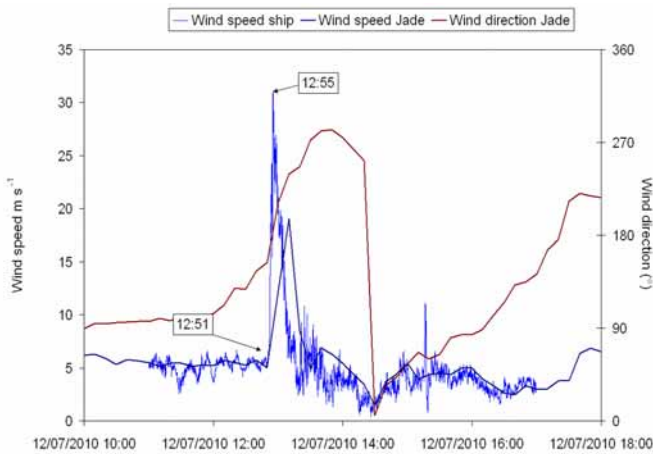
## Technical Developments in 2011

In 2010, the entire DES system was set up; the operation manual is available in the COSYNA Sharepoint website. A new development in 2011 was the automated operation of the ADCP, adapted to ship operations. Standard size data packages of ~0.5 MB were defined after which a new ADCP file is initiated. The data are automatically input into the HZG survey database, and automatic quality control has been started.

## Results (Highlights)

One good example for the usefulness of highly resolved ship data is the storm in July 2010 (Figure 2). The RV Ludwig Prandtl was docked in Wilhelmshaven port when a sudden storm arrived from a south-westerly direction which lasted only a couple of minutes. Figure 2 gives an impression of the event. The 10-min average values of the nearby pole station give a wrong impression since the averaging procedure reduces the maximum wind speed from ~ 32 to ~ 19 m s<sup>-1</sup>.

ADCP profiles recorded during transfer cruises are routinely used for calibration of the HF radar stations on the coast (Wangerooge, BÜsum, Sylt) which measure wave height and derive current velocity and direction (Figure 3).



**Figure 2:** Wind speed ( $m s^{-1}$ ) and wind direction on July 12th, 2010. The data from the 1 km distant pole station are 10 min averages. Since the duration of the storm was so short (rising time of only 4 minutes), the averaging procedure reduces the maximum wind speed of  $\sim 32$  to  $\sim 19 m s^{-1}$ .

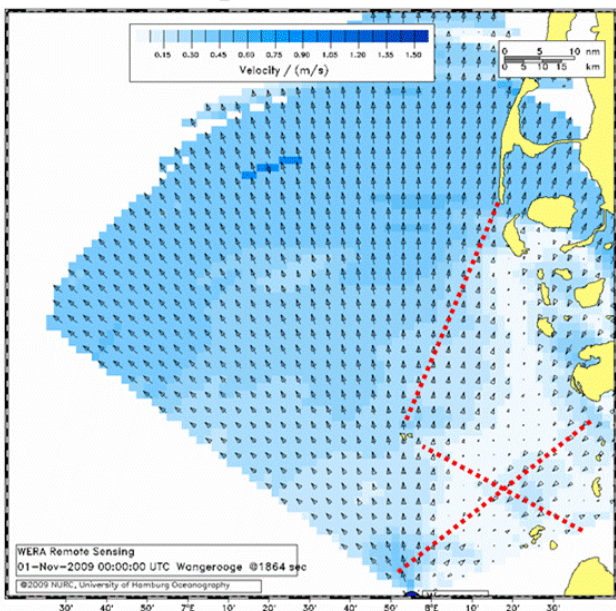
For any sampling operation on board, the meteorological / oceanographic data of DES may be used for reference purposes.

### Problems

- The modem sometimes is hung up during the day. Resetting the system every night solves the problem.
- If the system runs through the night, switching off of the ADCP control computer next day is a problem. The ADCP instrument is off, but the computer is still running. It is not yet clear where that error is created.

### Perspectives for 2012

The validation procedure of HF radar measurements with RV Ludwig Prandtl ADCP data will be continued and consolidated. The ADCP ship data may be used in the future for validation of the routinely running GETM model.



**Figure 3:** Area covered by the Wangerooge radar and course of the RV Ludwig Prandtl in November 2009.

# Integrative sampling for the analysis of chemical contamination

A. Prange / D. Pröfrock / H. Helmholz

## Location Cuxhaven

### Aims for 2011

The aim for 2011 was to equip the newly developed sampling infrastructure with passive as well as active samplers (*Mytilus edulis*) in order to test robustness of the installation under real world conditions and to allow a re-designing if necessary. A first generation of data sets should be generated

### Technical Developments in 2011

The main technical developments in 2010 were focused on planning and realizing a sampling platform at the "Seebäderbrücke" in Cuxhaven. In 2011 a continuous operation of this system could be realized (Figure 1a). Active samplers *Mytilus edulis* (av. 90 individuals per cage) were deployed at the end of May and were continuously sampled until January 2012.

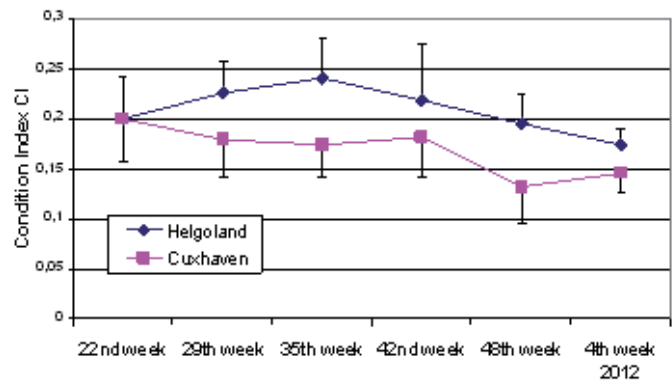
The implementation of passive sampler started with an optimisation of the deployment strategy in terms of size and fixation selection of the polymer sheets (Figure 1b). Supplementary laboratory experiments were focused on the development of cleaning and extraction procedures for the passive sampler material used and on the optimization of the spiking procedure, of the passive samplers with performance reference compounds, which are necessary to calculate the sampling rates of the passive sampling devices.



**Figure 1:** Sampling station at Cuxhaven equipped with active and passive sampler (a) in July (b) in September 2011

## Results (Highlights)

From May 2011 on a periodical sampling (every 6 weeks) was performed. Simultaneously also at the underwater node "MarGate" near Helgoland was sampled. Basic physiological data like condition index gave first hints on a different fitness of the Blue Mussels at these two stations (Figure 2). A bench of passive samplers have also been deployed and cleaning and placement strategies have been further improved.



**Figure 2:** Condition Index (CI) of *Mytilus edulis*; Mean $\pm$ SD ( $n=10$ ; 4th week 2012  $n=9$ )

## Problems

Problems arose during the year due to the development of a biofilm and the massive growth of hydrozoa and barnacles on all surfaces of the sampling equipment (see also Figure 1a). Due to an unknown reason two cages were lost during the deployment.

## Perspectives for 2012

A re-design of the infrastructure will be conducted in order to improve the flexibility and capacity of the station. With these modifications also the application of passive sampler for inorganic contaminants and sediment traps will be possible. In addition, the capacity of the sampling site will be extended to 16 positions. The HZG machine shop scheduled the finishing of the modifications for the end of February 2012. It is planned to start a new campaign and installing the new sampling devices during February/March at Cuxhaven. A continuous placement of passive samplers is planned for 2012. The 2011 data set including pollutant concentrations in active sampler and water samples will be accomplished.

## Location Helgoland

### Aims for 2011

The aim for 2011 was to install the sample holding infrastructure on one tetrapod located within the TN 10 field of “MarGate”. Simultaneous implementation and sampling of active sampler originating from the same population used in Cuxhaven should lead to a first generation of data sets.

### Technical Developments in 2011

The main technical developments in 2010 were focused on planning and realizing an underwater sampling platform. A system was developed, whose main parts are interchangeable with the sampling station at Cuxhaven. In April 2011 this could be realized in collaboration with the AWI scientific diving group (P. Fischer). The installation has been realized close to the BSH test location. Thus a joint sampling with the BSH could be performed several times.

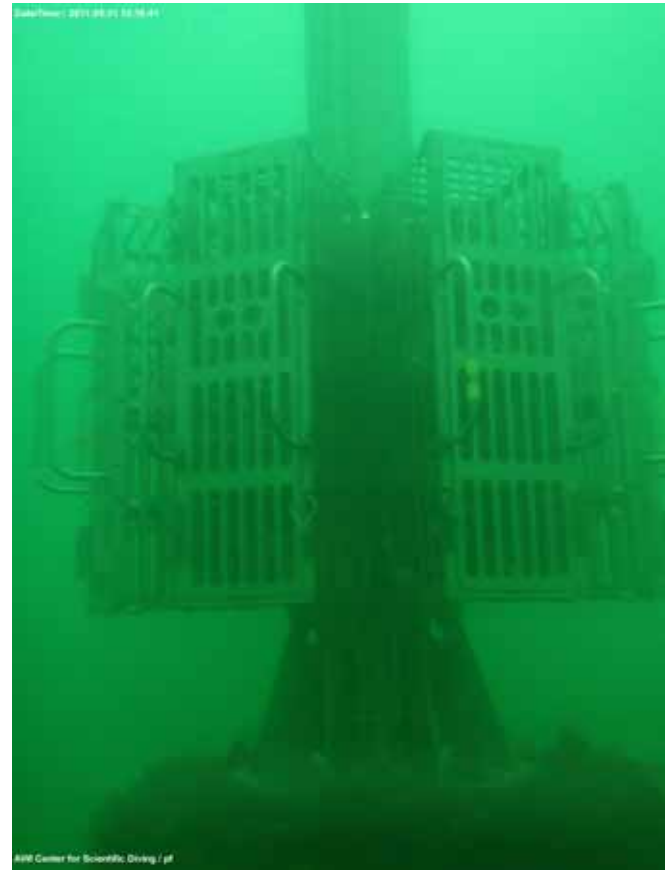
Active samplers in form of a package of Blue Mussels *Mytilus edulis* (av. 100 per cage) were deployed simultaneously to the Cuxhaven station by the end of May. A continuous sampling could be maintained until January 2012 (Figure 3). Laboratory experiments were performed to establish standard procedures for sample preparation and measurements of basic physiological data.

### Results (Highlights)

The 6 week period sampling was performed simultaneously to the Cuxhaven station. This logistic challenge could be sophisticatedly solved. Basic physiological data like condition index gave first hints on a different fitness of the Blue Mussels at these two stations (Figure 2).

### Problems

Problems arise during the year due to the development of a biofilm and the massive growth of hydrozoa and macrophytes. In addition some mussels were lost due to the feeding activity of crabs and sea stars, however the overall yield of mussels was still sufficient to conduct the planed measurements.



**Figure 3:** Sampling station at the field “MarGate” at Helgoland

### Perspectives for 2012

The same modifications as planned for the infrastructure of Cuxhaven will be realized at Helgoland. It is planned to start a new campaign and installing the new sampling devices during February/March. A continuous deployment of passive samplers is planned for 2012. The 2011 data set including pollutant concentrations in active sampler and water samples will be accomplished.

### Publications

Kraus UR, Profrock D, Erbsloh B, Lassen S, Helmholz H, Ruhнау C, Prange A, Walcher C, Fischer P, Theobald N (2011): Catch me if you can – Sampling approaches for time integrated monitoring of priority substances and their related effects in marine water bodies using passive and active samplers. BSH Symposium „The Future of Operational Oceanography“, Oktober 2011, Hamburg. (Poster presentation)

## First deployment of lander SedOBS

### C. Winter (for the working group "Near bed observation systems")

#### Aims for 2011

In August 2011 the construction of the lander SedOBS (KUM, Kiel) was ready for a first test deployment. Most of the sensors and instruments had been delivered by that date. The launcher unit was not yet ready for deployment at that date.

During a short cruise with FK Senckenberg to the German tidal waters Jade/Ahne August 8-12, 2011 the operation and performance of the lander was tested. Four deployments were carried out to test the operation of the pop-up systems and recovery routines, to test the technical performance of the sensor mountings, and the performance of the sensors.

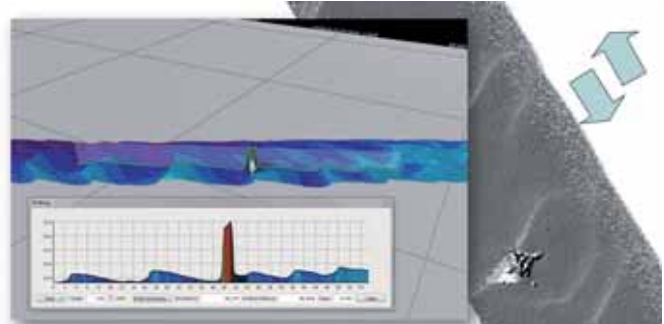
#### Technical Developments in 2011

The four deployments were all close to the western bank of tidal channel Ahne. The first two A, B without sensors to test the pop-up systems on Aug 8, the other two deployments C (Flat seabed position): N 53°32.259'; E 8°11.897' (WGS84) from 09.08.11 15:40 until 10.08.11 10:00; and D (small dunes seabed position): N 53°32.284' ; E 8°11.841' (WGS84) from 10.08.11 17:15 until 12.08.11 06:40.



**Figure 1:** Lander SedOBS and sensors after deployment C

All deployments were monitored by Multi-Beam-Echo-Sounder (MBES) surveys before and after the release of the lander (Figure 2).



**Figure 2:** Position of the lander in a field of small dunes in Ahne tidal channel. Unfortunately the lander was deployed with the legs towards the tidal currents. Thus hydrodynamic data is expected to be disturbed by the eddies released from the upstream leg. Future campaigns will utilise a launcher unit with a fin, which will help to correct the orientation of the lander in the tidal currents.

The lander was easy to assemble and disassemble on board, even with limited space on deck of FK Senckenberg. Both (redundant) pop-up systems were working without problems. The line and chain system worked fine, except the chain ducts (plastic pipes) which are to avoid contact of the chain with the sensors during recovery broke after the third deployment. Thus some further development is required.

#### Results

All instruments were checked for technical functioning:

**CTD 90M:** Worked fine during last deployment (D), after battery replacement and new configuration,

**ADCP 600:** Worked fine during deployments C and D,

**ADCP 1200:** Worked fine during deployments C and D,

**LISST 100X:** Did record data during deployments, but technical problem remain: Corrosion and laser power low. Instrument was sent to SEQUOIA German distributor MBT for maintenance and re-alignment of the laser.

**Nortek Vectors:** Worked as expected during deployment D. Second Vector was not delivered at the time of cruise.

---

**Eddy Correlation sensor:** Worked during deployments C and D, some technical questions (data storage, formats) remain. Manufacturer was informed. Answers are still pending. Started technical and scientific co-operation with Moritz Holtappels (MPI Bremen) for operation of Eddy Correlation.

**ME 3D Profiler:** Worked initially during deployment D, then broke down. Instrument was sent to manufacturer for repair (warranty).

**Imagenex sonar:** Worked during deployment D, however was programmed wrongly.

**FastTrackall:** Was not completely delivered at the time of cruise.

Several technical questions remain about optimisation of sensor settings, formats, storage, power consumption. Thus small craft / laboratory deployments are envisaged to test operation under controlled boundary conditions.

## Problems

The lander was deployed without the launching unit. Unfortunately it turned while it was lowered to a position with the legs directed towards the tidal currents. Thus data is expected to be disturbed by the eddies released from the upstream leg (Figure 2). Future campaigns will utilise a launcher unit with a large fin, which will help to correct the orientation of the lander in the tidal currents.

## Perspectives for 2012

Ship time for further deployments is available in February 2012 (5 days Heincke), June (7 days Heincke), July (5 days Senckenberg), September (5 days Senckenberg).

# NuSOBS

J. Friedrich

Nutrient and Suspension Observatory team: Kay Emeis, HZG (Mc Lane Samplers), Jana Friedrich, AWI, HZG, Michael Schlüter, AWI (Lander frame, flux chambers, CTD), Oliver Zielinski, IMARE (Nitrate and DOM dynamics)

## Aims for 2011

In 2011, the NuSOBS lander was to be built by K.U.M. Umwelt- und Meerestechnik Kiel GmbH.

## Technical Developments in 2011

The goal was to build and test an autonomous seafloor-based observatory for time-series measurements of

- dynamics of nutrients and oxygen in the near-seafloor water column
- sediment-water fluxes of nutrients and oxygen consumption
- nutrient dynamics within the sediment

The lander frame has been finalized by the manufacturer in December 2011. In February 2012, the acceptance procedure and introduction to the main lander and sensor functions has been carried out at the K.U.M. workshop in Kiel. Introduction was provided by K.U.M. and by Sea & Sun Technology GmbH. The lander will now be transferred to AWI, the main user of the instrument within COSYNA. Tests at sea are foreseen for June 2012 on RV Heincke.

The NuSOBS observatory will eventually allow to quantify benthic nutrient budgets and to estimate the role of the benthic-pelagic coupling at selected locations within the German Bight.

The observatory/benthic lander system will provide the following COSYNA parameters:

- Category 1 - water temperature, salinity, currents, turbidity, oxygen in the bottom water
- Category 2 - biogeochemical parameters like pH, nutrients, alkalinity in the bottom water and TOC, DOC, TIN, TON, sediment-water fluxes of oxygen and nutrients, porewater, profiles of oxygen and nutrients in the bottom water.

The in-situ measurement system for nitrate and dissolved organic substances will be operated on the SedOBS lander as it requires undisturbed hydrographic conditions. This would not be the case on the chamber lander. The flexible design allows for attachment to different future lander systems.

In the prototype version, the NuSOBS lander consists of two benthic flux chambers equipped with optode and pH sensors in each of the chambers, syringe sampling units and lander electronics. The data from within the chambers is recorded by a Sea&Sun CTD 115 unit. Outside the chambers, the CTD will record temperature, salinity, turbidity, chlorophyll and oxygen. A current meter will record vertical and lateral currents.



**Figure 1:** NuSOBS at the workshop of the Manufacturer K.U.M. Umwelt- und Meerestechnik Kiel GmbH.

## Results (Highlights)

No results have been achieved yet, as first seagoing test of NuSOBS is foreseen for June 2012.

## Perspectives for 2012

The lander will now be transferred to AWI, the main user of the instrument within COSYNA. Tests at sea are foreseen for June 2012 on RV Heincke.



# hypOO

O. Zielinski

## Aims for 2011

Colour of seawater in coastal seas has experienced growing interest for assessment of the environmental status. Using hyperspectral optical sensing from above the sea surface it is feasible to obtain long term records of radiometric quantities. However, meteorological conditions and sunglint along with sensor setup affect the validity of optical sensing. Here, our overarching goal was to develop technology and protocols capable of obtaining valid radiometric quantities from automated and unmanned seaborne as well as fixed platforms. These valid quantities were then used to infer colour producing agents in seawater and perceived colour of seawater.

## Technical Developments in 2011

Installation at RV Heincke was realized in the shipyard. Data acquisition is automated and available from a ruggedized system onboard. Using the camera system installed on RV Heincke cruise HE302 a sunglint detection algorithm was developed.

## Results (Highlights)

We developed a protocol on how to eliminate radiometric quantities contaminated with sunglint and meteorological effects. It utilises a simple image algorithm that detects the amount of light exposure in a given sea surface image. These sea surface images were collected using a novel camera system installed on RV Heincke (see Garaba et al. 2011 for a full description of the instrument setup).

Quality controlled hyperspectral remote sensing reflectance data were transformed into values ranging from 1 (indigo-blue, oligotrophic waters) to 21 (cola brown, hyper-eutrophic waters) matching the Forel-Ule scale (Wernand and van der Woerd, 2010). Figure 1 was generated to show perceived colour of seawater along with matching numeric values on the Forel-Ule scale. Utilizing hyperspectral radiometric and sampled in-situ information a number of bio-optical relationships were computed, e.g. that coloured dissolved organic material acts as a good indicator for both salinity and perceived colour of seawater.

**Figure 1:** Perceived colour of seawater from the sampled stations aboard RV Heincke during cruise HE302 between 21 April and 14 May 2009.

## Problems

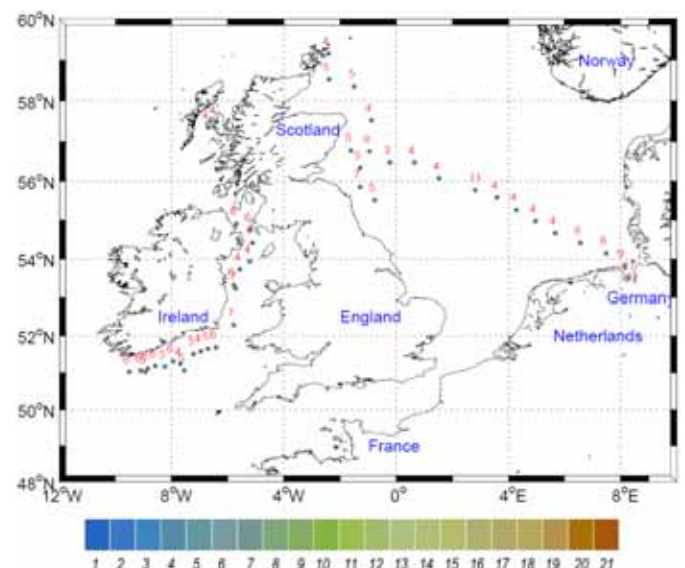
Data transmission of the camera systems is unstable and requires ethernet repeaters along the wiring. Quality control of hyperspectral measurements from a seaborne platform still needs technological improvements. The ‘pitch, yaw and roll’ motions of a research vessel make it a challenge to collect measurements as per classic protocol. External effects that contaminate optical measurements constrain the applicability of automated and unmanned platforms. Of major concern is the solar radiation during winter episodes and night time.

## Perspectives for 2012

Technical stabilization of the data transmittance onboard RV Heincke. To increase the number of usable spectra we aim to develop a dynamic optical sensor setup that can reposition itself to avoid sunglint and adapt sensor direction to platform position. Using available radiometric and in-situ information we aim to validate bio-optical models and quality control methods.

## Publications

- Garaba SP, Wernand MR, Zielinski O (2011): Quality control of automated hyperspectral remote sensing measurements from a seaborne platform. *Ocean Science Discussions*, 8 (2), 613-638. doi:10.5194/osd-8-613-2011
- Wernand MR, van der Woerd HJ (2010): Spectral analysis of the Forel-Ule Ocean colour comparator scale. *Journal of the European Optical Society - Rapid Publications* 5, 10014s. doi:10.2971/jeos.2010.10014s



# Underwater node

P. Fischer

## Aims for 2011

The main goal for 2011 was to set up the necessary infrastructure and technical environment for the installation of the first COSYNA UW-nodes system off Helgoland and to start assembling and testing the node-hard- and software in close cooperation with the involved external companies. The necessary steps were planned in a timeline allowing the final installation of the node system off Helgoland in June 2012.

The following milestones were planned for 2011:

- 1) Finishing the land-based installations for the planned UW-node off Helgoland.
- 2) Final definition of the technical typology of the COSYNA UW-node system.
- 3) Construction and testing of the basis modules of the UW-node.
- 4) Software programming for node control and data storage.
- 5) Adapting a surface buoy for testing the autonomous operation of sensors and later connection to the UW-node system.

## Measurement Strategy within COSYNA

All planned milestones were fulfilled. The process of assembling and testing the main hard- and software modules of the UW-node system was also used to test and verify the basic AK strategy: That the node system is fully compatible with the other COSYNA components as well as with most sensors available on the international sensor market. As far as these tests have been done so far, it can be stated that this basic idea is fulfilled by the node system. All (partly highly complex) sensors attached to the node system were successfully integrated in the node configuration and could be operated. For these tests, a first test version of the planned UW-node system was set up under water in the south harbour of Helgoland.

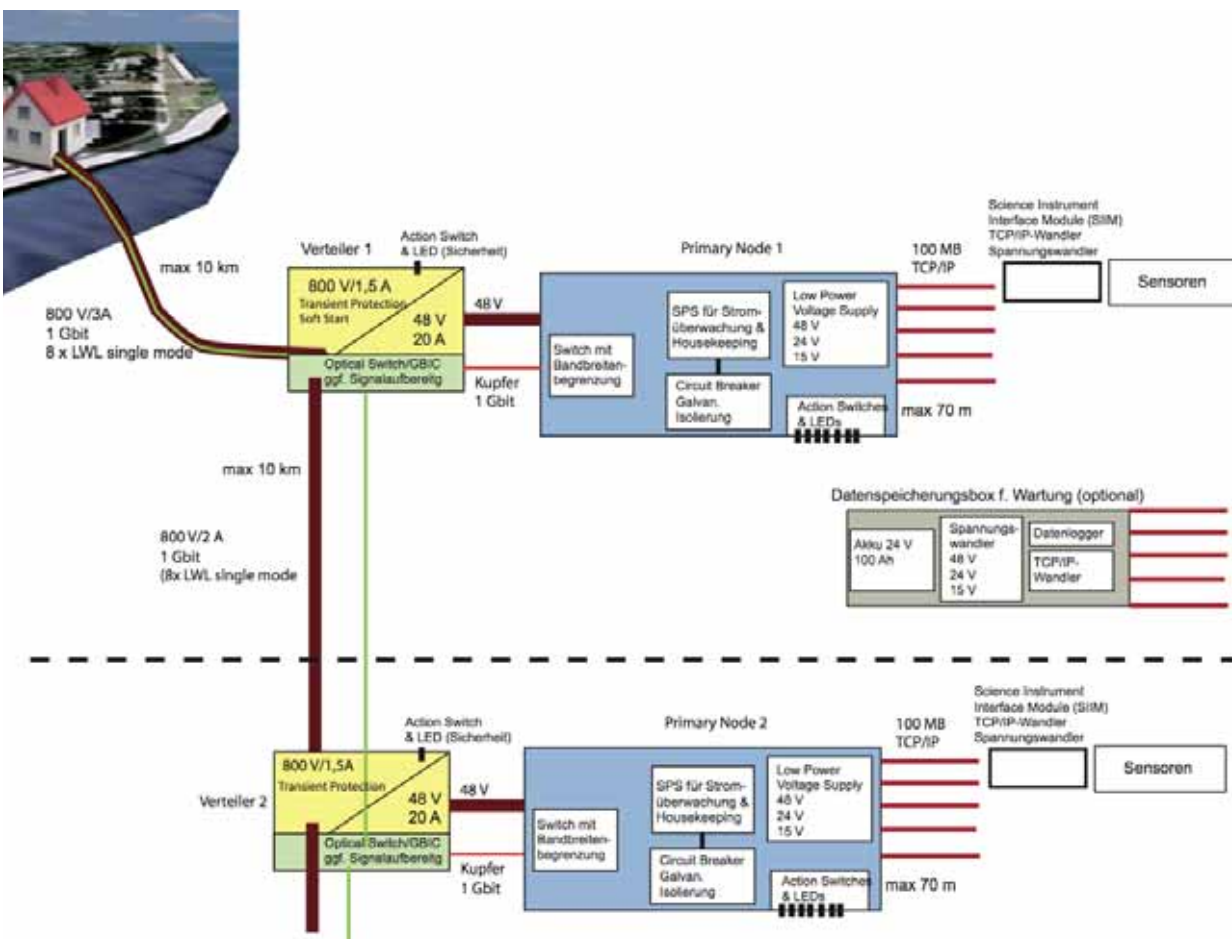


Figure 2: Technical typology of the UW-node system

**Milestone 1: Finishing the land-based installations for the planned UW-node off Helgoland (Figure 1).**

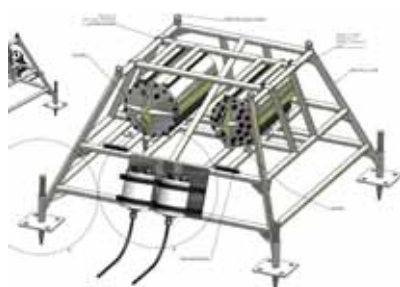
- a) The installation of the necessary power and fibre-optic cables to the land-water transfer station at Helgoland "Bollwerk" has been finished.
- b) The central COSYNA Server at Helgoland is installed and tested.
- c) The necessary wireless high-speed data connection from Helgoland to the main land (AWI -> DFN network -> HZG -> COSYNA Data Server) is established.



*Figure 1: General arrangement of the COSYNA UW-node system off Helgoland*

**Milestone 2: Final definition of the technical typology of the COSYNA UW-node system (Figure 2)**

The final technical specifications of the UW-node have been fixed. Based on a cost-effect calculation, a maximum distance of 10 km between the land station and the first UW-node has been defined with optional to additional node systems each extending the range for 10 km - so that a maximum distance of 30 km can be reached from the land control system (COSYNA Server).



*Figure 5: Main node system with lander construction*

**Milestone 3: Construction and testing of the basis modules of the UW-node.**

- a) The underwater power and fibre-optic connection cable was ordered and the necessary UW-connectors were designed and assembled (Figures 3 and 4).
- b) The main housing of the node system including all electronic equipment necessary for node control incl. a battery pack for 3 hours fully autonomous operation during power shutdown was constructed and started to be assembled (Figure 5).
- c) The lander system for the COSYNA sensors Category I and II was defined and assembled (Figure 6).



*Figure 3: UW-power and data cable for COSYNA*



*Figure 4: UW-breakout box between the cable and the node*

**Milestone 4: Software programming for node control and data storage**

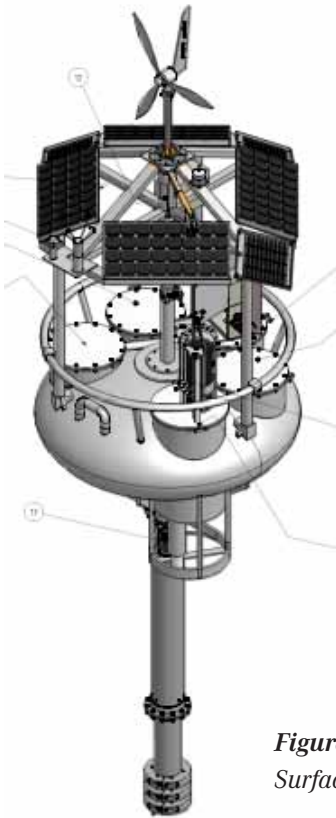
The necessary network typology and software for the node control was finally defined and started to be assembled respectively programmed

**Milestone 5: Adapting a surface buoy (Figure 7)**

A surface buoy for testing the autonomous operation of sensors and later connection to the UW-node system was adapted to the node technology.



**Figure 6:** Lander system for the sensors (COSYNA Category I and II)



**Figure 7:** Surface buoy

## Technical Concept

The following specifications are realized in the UW-node

- The maximum distance of the first node to the nearest land-station is 10 km. The system is designed for the integration of two additional nodes each extending the range for another 10 km. In the maximal version, the system can provide power and data access in a distance up to 30 km from the land control system (COSYNA Server).
- Maximum operation depth 100 m
- The system is equipped with 10 potential high-speed UW-connectors (100 MBit/100 Watt). The available power and network resources for the sensors can be remotely managed by the system operator. For all sensors attached to one node, an overall power supply of 1000 Watt and a maximum data transfer rate to the land based server of 1 GB is available.
- Standard communication protocols of the node are TCP/IP with adapter technology for RS232, RS424, RS485, CAN-Bus, USB and Video.
- The system is prepared to support SOS technology for the sensors.
- Possible later integration of international communication protocols like PUK (integration of metadata in the communication protocol).

## Ordering of instruments

- Underwater data and power cable for the node (1 km)
- Node hardware including lander system, power supply and UW battery pack system (4hJena)
- Network hardware and software for UW node control (Loth)
- COSYNA Server for the land station (Loth)
- Lander system for sensors (KUM)
- Subconn connector cables for connecting the node system, the battery pack systems and the sensors to the node systems (M-B-T).
- CTD (Sea&Sun)
- WorkHorse Sentinel ADCP

# MOKI

H.-J. Hirche / J. Schulz

---

## Aims for 2011

The zooplankton recorder MOKI is based on a prototype (LOKI) for towed application developed during the last 6 years. In order to update the technical components and adapt the system to a moored deployment, the development has been planned in 2 steps for 2010 and 2011.

## Main goals for 2011 were

- Manufacturing of optical system (GigE-digital camera [1.3 - 4 MPix], macro lens, illumination system)
- Manufacturing of measuring head (laboratory version)
- Construction of field system (camera, optics, illumination, measuring head, embedded-PC)
- Test setup of field system in the laboratory
- Planning of adaptation and integration to COSYNA underwater-node

## Results (Highlights)

- Manufacturing and setup of field system consisting of optical system and measuring head (Figure 1)
- Two prototypes of measuring heads were developed, manufactured and tested in laboratory.



**Figure 1:** MOKI. Optical underwater unit with flow-through imaging head

## Problems

Laboratory tests with the first designs of imaging heads revealed the need of modifications and further test in the laboratory before final deployment.

## Perspectives for 2012

- First in-situ deployment at COSYNA underwater node (Helgoland) in summer 2012
- Development of concepts for data analysis and management
- Further development on image analysis (Zooplankton classification)
- Evaluation of the possibilities for deployment of MOKI in the Kongsfjord (Spitsbergen)

## Publications

Hirche H-J, Schulz J, Hanken T (2012): A modular imaging system for collection and analysis of live and preserved zooplankton samples. IEEE (in press)

# Automated nucleic acid biosensor system for observing phytoplankton – AUTOSENS

K. Metfies

## Aims for 2011

We applied for a nucleic acid biosensor system, that allows to carry out analyses of phytoplankton with high resolution in time and space.

For 2011, it was planned to develop an automated filtration module for the nucleic acid biosensor system that can be used for routine sampling, storage of phytoplankton, and subsequent analysis with the biosensor system.

Construction and production of the automated filtration module was ordered from iSITEC GmbH in Bremerhaven at the end of 2010. First tests of the device were planned for spring 2011.

## Measurement Strategy within COSYNA

In combination with the FerryBox system the nucleic acid biosensor system is supposed to generate regular information on the occurrence of phytoplankton key species in the North Sea.

## Technical Concept

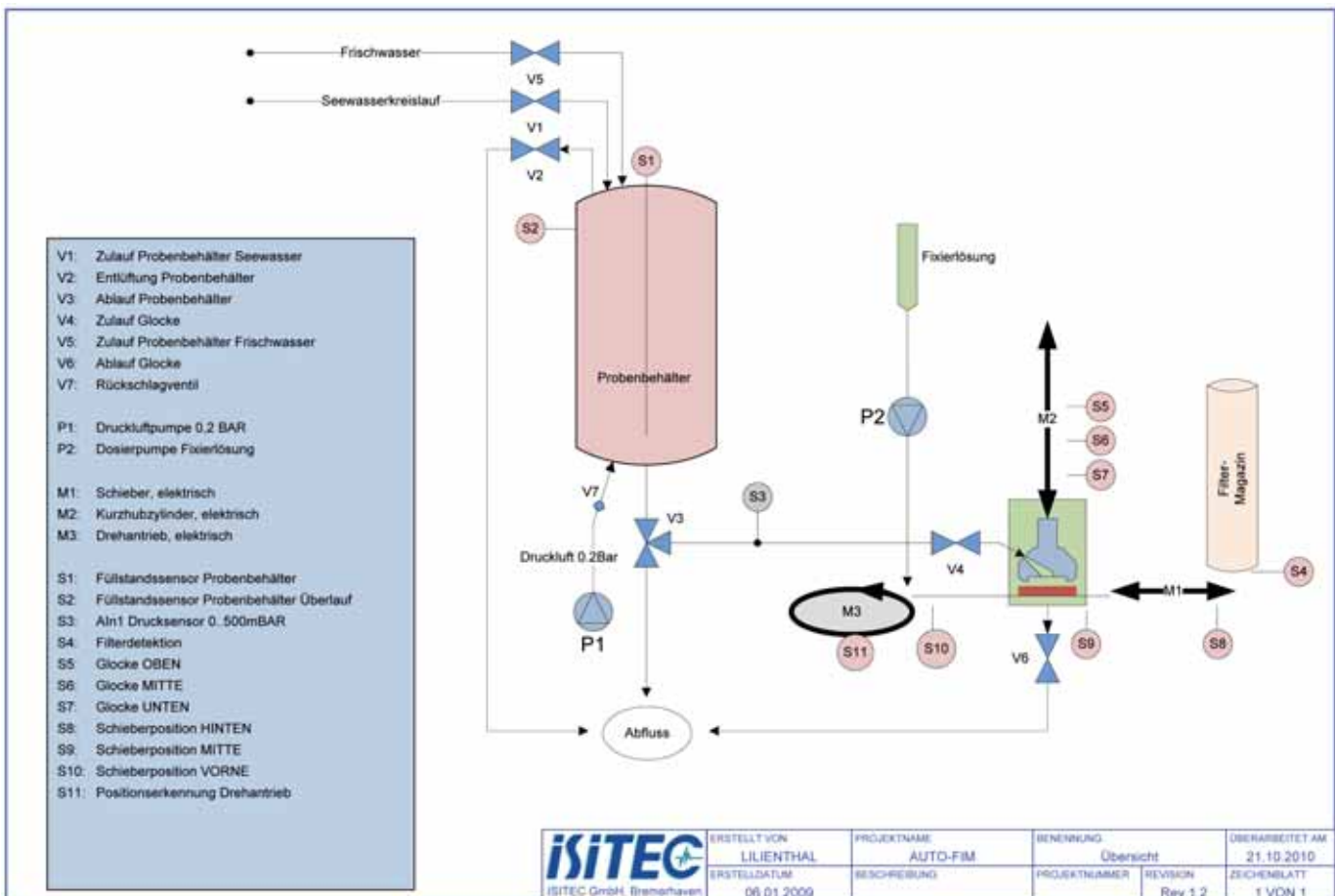
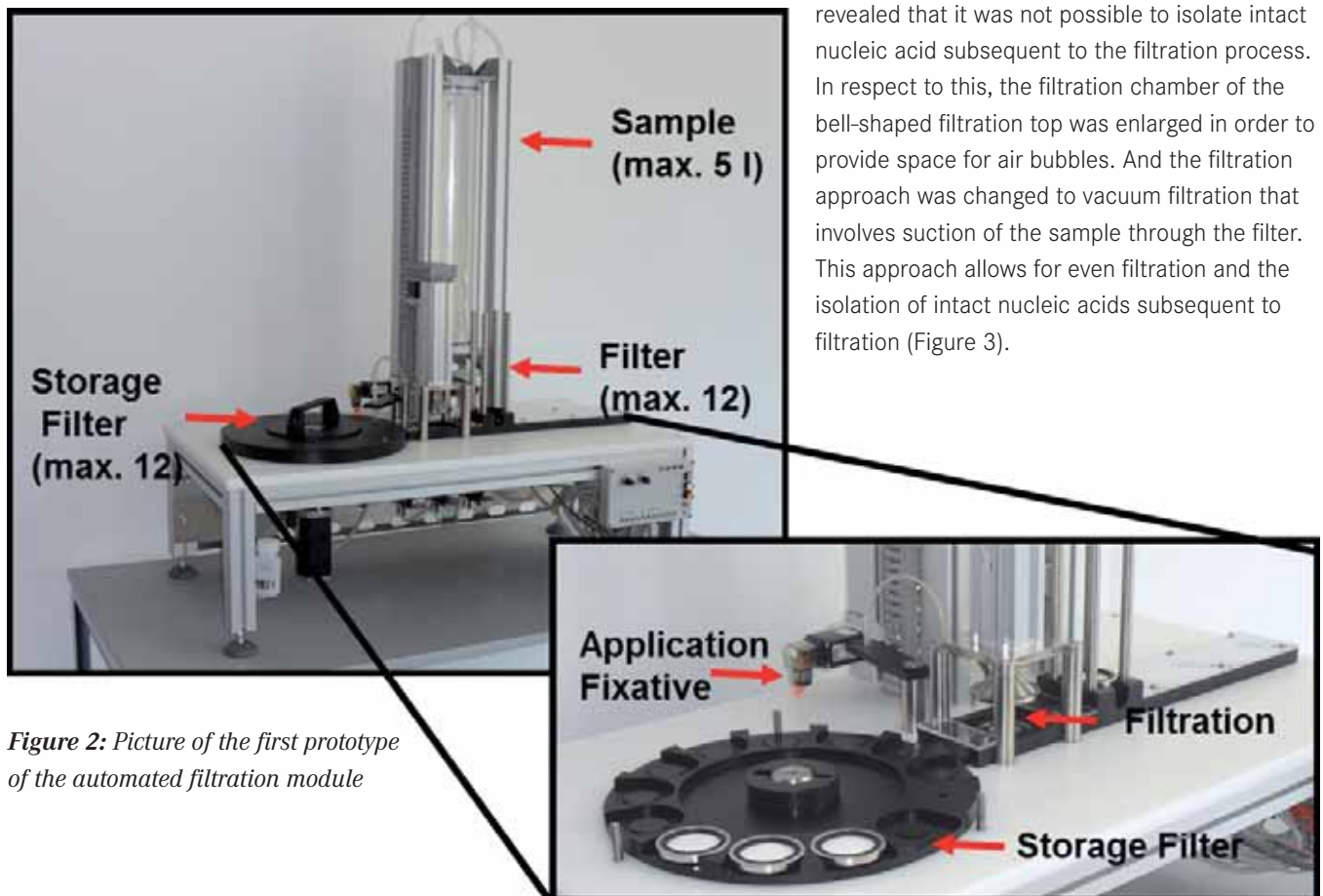


Figure 1: Technical concept of the nucleic acid biosensor system

## Technical Implementation



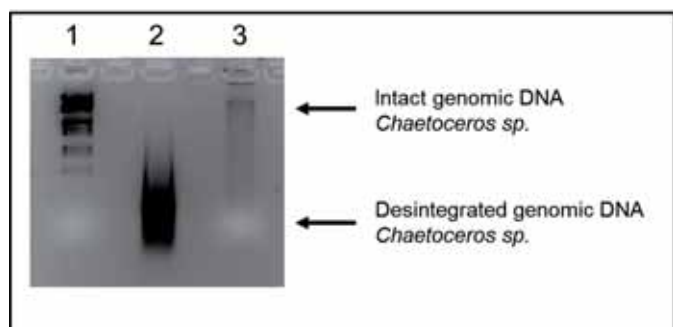
**Figure 2:** Picture of the first prototype of the automated filtration module

As planned, a first manually controlled prototype of the automated filtration module was tested in spring 2011. The prototype consists of a sample reservoir for a maximum sampling volume of 5 l. Filters are stored in a reservoir and pushed prior to filtration under a bell-shaped filtration top. Subsequent to filtration a fixative is applied onto the filters and they are pushed into the filter storage system (Figure 2).

In the first prototype, filtration was carried out by applying pressure to the sample reservoir, pushing the sample from the sampling reservoir through the bell-shaped filtration top onto and finally through the filter. The cells in the sample were collected on the filter. With this approach, a number of problems occurred that required optimization of the first prototype. On the one hand, air bubbles got stuck on the filter and hampered filtration of the sample on the filter or even blocked the filter. Furthermore, isolation of the DNA

revealed that it was not possible to isolate intact nucleic acid subsequent to the filtration process. In respect to this, the filtration chamber of the bell-shaped filtration top was enlarged in order to provide space for air bubbles. And the filtration approach was changed to vacuum filtration that involves suction of the sample through the filter. This approach allows for even filtration and the isolation of intact nucleic acids subsequent to filtration (Figure 3).

To test the filtration device 1 l of *Chaetoceros sp.* (8 mio cells/l) were filled into the sample reservoir and filtrated. Subsequent to the filtration, genomic DNA was isolated from the cells on the filter. The integrity of the nucleic acids was analyzed on an agarose gel. On an agarose gel, disintegrated partial nucleic acid moves faster and are visualized as a cloud in the lower part of the gel-picture. If the cells were pushed through the filter, the nucleic acids were disintegrated (lane 2), while the genomic DNA isolated from cells that were sucked through the filter appeared as an intact distinct band of nucleic acids in the upper part of the gel picture (lane 3).



**Figure 3:** Agarose Gel of genomic DNA isolated with the first prototype of the filtration module and with the optimized prototype of the filtration.

Currently the control of the filtration process is automated and the filtration module will be available for integration to a FerryBox in spring 2012.

### Probe Development

Target species were identified by their appearance and contribution to the phytoplankton composition in the southern North Sea. Species were chosen as target species that regularly occur with high abundances or occur only sporadically with low abundances. It is expected that environmental change could result in changing abundances of the target species. The abundance of species with high regular abundance could decrease or the abundance of species with low abundance could increase.

### Target Species:

1. *Chaetoceros calcitrans*
2. *Chaetoceros debilis*
3. *Chaetoceros socialis*
4. *Ceratium furca*
5. *Ceratium fusus*
6. *Leptocylindrus danicus*
7. *Leptocylindrus minimus*
8. *Odontella aurita*
9. *Odontella sinensis*
10. *Paralia sulcata*
11. *Prorocentrum micans*
12. *Pseudonitzschia seriata*
13. *Pseudoditzschia delicatissima*
14. *Pseudonitzschia pseudodelicatissima*

Molecular probes have been designed for all target species. In total 33 probes have been tested for their specificity. Currently we are working on the adaptation of the specific probes to the biosensor format.

### Perspective for 2012

For 2012 it is planned to integrate the automated filtration module to a FerryBox e.g. in Cuxhaven and test the device in the field. And furthermore, the automated filtration module has to be connected to the automated biosensor module.



# Research platform Spiekeroog

T. Badewien

## Aims for 2011

- Since autumn 2002, the ICBM has been running the research platform Spiekeroog. The aim is to renew the time series station by applying new technical concepts and new instruments. Another aim is to integrate the research platform into the national pre-operational initiative COSYNA.
- Another aim is the implementation of new quality assurance methods. These are developed by the COSYNA working group “quality assurance and data management”.

## Technical/ Program Developments in 2011

- In March 2011, the ICBM submitted a proposal concerning the update of the research platform Spiekeroog to the COSYNA Scientific Steering Committee.
- In April 2011, the HZG granted the proposal with reduced budget.
- We have developed a new concept in order to improve the existing technical equipment and instrumentation of the research platform Spiekeroog.
- After a detailed analysis of the market, we opened a call for tenders (to five companies) in order to choose a qualified company.
- In September 2011, a scientific and technical committee of the ICBM and the HZG commissioned -4H- JENA engineering GmbH to update the research platform Spiekeroog.
- In September 2011 start of the update of the research platform Spiekeroog.
- Most of the new instruments have been provided in 2011.
- In order to exchange information and watch the progress of the work, technicians and scientists of the ICBM, the company -4H- Jena engineering GmbH and the HZG hold a video conference every two weeks.

## Results (Highlights)

- A scientific and technical committee of the ICBM and the HZG commissioned the company -4H- JENA engineering GmbH to update the research platform Spiekeroog.
- The cooperation between -4H- JENA and the ICBM functions well and supports the development of new technical approaches.



*Figure 1: Research platform Spiekeroog, May 2011*

## Problems

- The update of the research platform Spiekeroog is running smoothly.

## Perspectives for 2012

- In a first step, the new system will be completely built up onshore.
- After the testing period onshore will be finished, the old and the new system will be installed on the research platform Spiekeroog and operated in parallel for some weeks.
- New research approach is necessary for a redundant data processing, storage and transmission system. This will be accomplished in co-operation between the company -4H- JENA and the ICBM.
- Implementation of the COSYNA quality assurance methods in order to deliver high quality data to the COSYNA data portal.
- The complete update of the research platform should be finished at the end of the year 2012.

## Numerical models

E.V. Stanev / J. Staneva / K. Wahle / A. Behrens / G. Gayer / W. Koch

---

### Aims for 2011

Concerning numerical models the main goals for 2012 were

- sensitivity studies concerning the impact of stratification on the propagation of the tidal wave in the German Bight
- sensitivity studies concerning the impact of small scale bathymetry features on the circulation in the German Bight
- first steps towards a coupling between the the circulation model and the ocean wave model.

In addition the further optimisation of the pre-operational COSYNA model forecast system was an objective for 2011.

### Program Developments in 2011

In order to study the sensitivity of the circulation model with respect to bathymetry and stratification ensemble runs were performed with different bathymetry data sets and perturbed input fields. Furthermore experiments were conducted to test different boundary conditions at the open boundary of the nested German Bight model. The results will be used to fine tune the model.

There are also ongoing activities concerning validation of the model results with different types of in-situ data. Furthermore different models (including the BSH model) were cross-compared.

There were some important advances made in the implementation of a coupling between the ocean wave model and the circulation model. This is an essential step for the development of a SPM assimilation scheme in the final COSYNA phase.

Furthermore the pre-operational model forecast system was adjusted to the changes of the disk space structure made in 2011.

### Results (Highlights)

In 2011 several important steps were made, which are required for the development of the next COSYNA products, in particular

- first results on ocean wave/current model coupling
- sensitivity and validation studies.

The validation studies included first comparisons with glider data. It should also be mentioned that the pre-operational circulation model results are used for the operation of the glider.

### Problems

There is some lack of ADCP data to validate current profiles of the model.

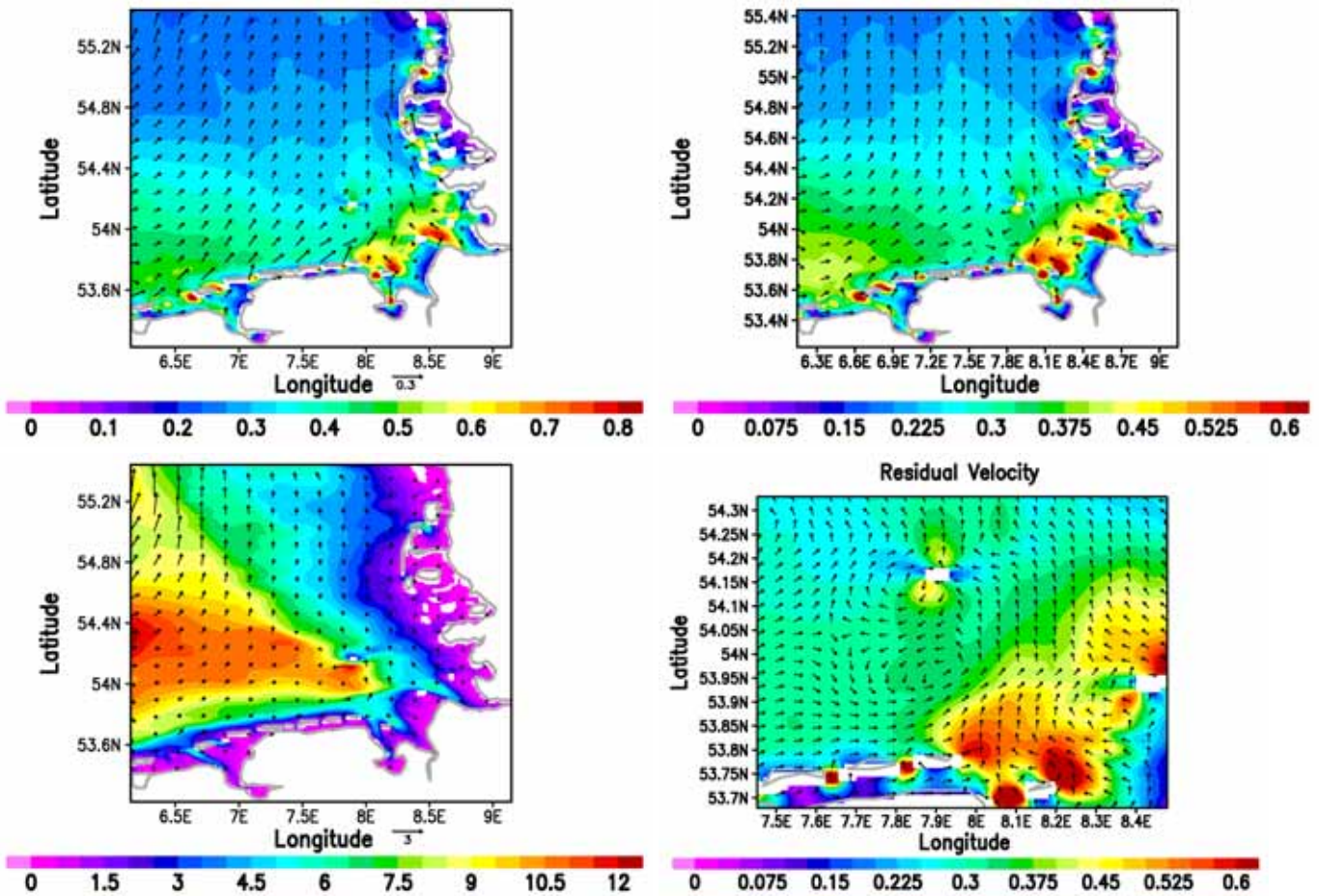
### Perspectives for 2012

The work on ocean wave/current model coupling will be continued. Furthermore there will be growing focus on the SPM modul of the circulation model.

It is likely that the sensitivity studies performed in 2011 will lead to an update of the pre-operational system setup in 2012.

### Publications

Stanev EV, Schulz-Stellenfleth J, Staneva J, Grayek S, Seemann J, Petersen W (2011): Coastal observing and forecasting system for the German Bight – estimates of hydrophysical states. *Ocean Science*, 7, 569-583.



*Figure 1: Eulerian time-mean of currents simulated by the German Bight model for the entire 2011: a) surface currents (m/s), b) vertical mean of currents (m/s) and c) vertically integrated currents ( $m^2/s$ ), d) as b) but zoomed around Helgoland area. Colour-coded according to the colourbars. The arrow below each plot corresponds to current or vertically integrated current in m/s or  $m^2/s$ , correspondingly.*

# Data management & quality assurance

G. Breitbach, J. Gandraß

## Aims for 2011

Major aims for Data Management (DM) and Quality Assurance (QA) were:

- The adoption of an internationally used quality flag scheme to COSYNA
- The preparation of the portal for using quality flags
- The definition of procedures for establishing quality flags in near real-time. Development and improvement of near real-time Quality Control including the establishment of regional climatologies and intercomparison of differing workflows/ algorithms with test data sets
- Intercomparison of measurement techniques and evaluation of measurement uncertainties
- Various requests of the DM&QS working group for getting more user-friendly within the COSYNA data portal CODM

## Technical Developments in 2011

New versions of the CODM portal as well as the database applications Tsdatab and Ferrydata were developed. Procedures for quality control in near real-time get defined and were developed.

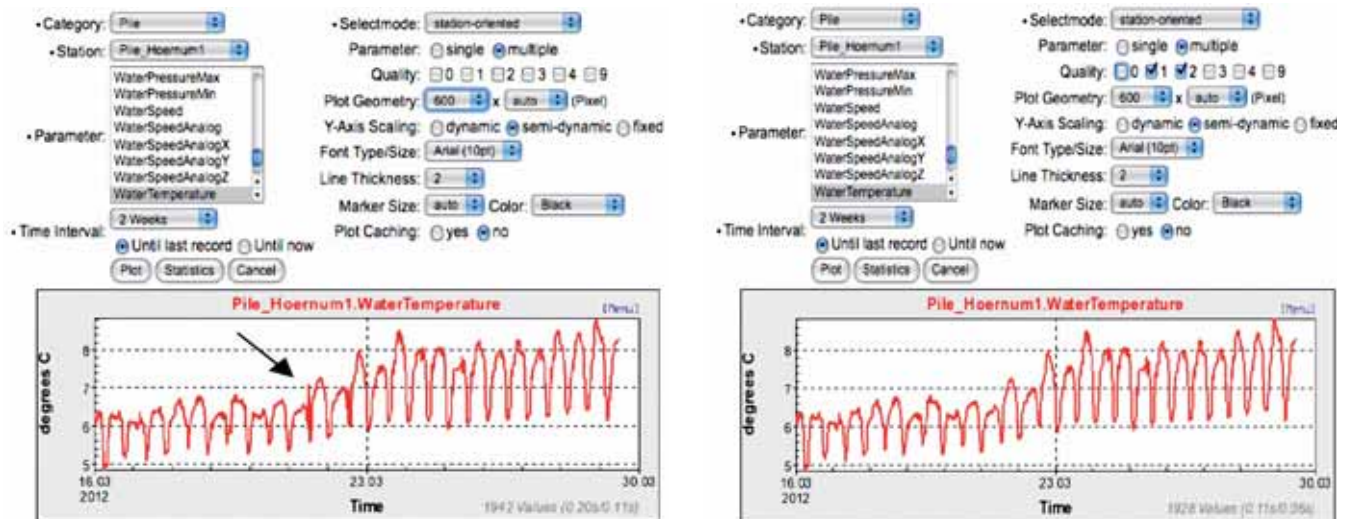
For the majority of parameters quality control procedures are still under development. Climatologies from long-year measurement stations were evaluated. For water temperature and salinity they can be used for monthly resolved range checks in near real-time quality control. First comparisons for different measurement techniques were conducted.

## Results (Highlights)

A COSYNA Quality Assurance Framework was approved and released. It defines schemes for quality flags and data levels and guidelines for processing and quality control for data from the COSYNA consortium. COSYNA partners adopted a subset of CF Standard Names und SeaDataNet/BODC codes to be used for COSYNA data. First documents on processing and quality control in the near real-time and delayed mode were approved and released.

The databases Tsdatab and Surveydata were modified to allow filter for viewing data with quality flags (Figure 1).

As could be seen in Figure 1 the new developed quality procedures enhances the quality of the data.



**Figure 1:** Comparison of two images from Tsdatab for the water temperature of Pile Hoernum1. **Left:** Without filter on quality flags. **Right:** Only good (qf=1) and probably good (qf=2) data shown. The marked data during a maintenance are removed due to quality flags

---

In the COSYNA data portal CODM parameter categories were included to reduce the amount of parameters seen by users at a glance. In addition, easier and well known parameter names were used.

A new search filter for the depth is added. With that search filters in 4 dimensions are possible.

The MARNET data for the German Bight by the BSH were included into the COSYNA time-series database and can be searched via CODM.

### Perspectives for 2012

- Further development and release of near real-time and delayed mode quality control procedures
- On-going intercomparison of measurement techniques and evaluation of measurement uncertainties
- The full integration of quality flags into CODM
- An integrated view for maps with time-series of fixed stations

# COSYNA communication: Outreach & inreach

C. Eschenbach

## Aims for 2011

COSYNA communication aims to present and convey COSYNA content to different target groups and the media. Technological and strategic aspects play a role in the development and implementation of adequate, creative and effective communication solutions. Communication tools need to be chosen and combined in accordance with the different purposes and target groups.

## Conceptual Developments in 2011

In order to structure and co-ordinate COSYNA communication activities a COSYNA communication concept was developed. It elucidates the following aspects to be done to communicate COSYNA: (1) Make the positioning of COSYNA transparent. (2) Identify target groups and communication objectives. (3) Select suitable communication tools and media. (4) Develop a plan of future activities. (5) Perspectives. The communication concept needs to be constantly adapted to new developments and changing framework conditions.

Some notions on the identification of target groups and communication objectives are given in the following.

COSYNA communication addresses

- 1) COSYNA members (internal communication) and
- 2) external target groups (external communication).

For both groups communication is guided by the same question: "What do we seek to communicate with and for whom?"

**1) Internal communication** contributes to optimizing organizational processes and increasing motivation by enhancing participation and contributions of all partners. Preparing and taking decisions is underpinned by co-ordination processes and discussions with the persons/parties concerned. Mutual openness and reliability contribute to a sense of community, facilitate acceptance of decisions, and create a good working environment.

Target groups of internal communication include all COSYNA members, and sub-groups of these depending on the questions to be answered.

**2) The general aim of external communication** is to publicize COSYNA and to generate public trust and understanding for COSYNA activities. This also supports the "marketing" of COSYNA products. With a view to future funding phases, the objective is to highlight the strategic significance of COSYNA with respect to answering future societal challenges. Rather than a one-way information flow from COSYNA to the users, this should be a two-way information flow where the users themselves can provide feedback and input to COSYNA. Effort is required to initiate and maintain such mutual feedback.

Target groups of external communication are heterogeneous, comprising the scientific community as well as public authority representatives from the regional to EU level. Representatives of industry and associations represent another important target group, e.g. wind farm operators, tourism, fisheries and nature conservation. The COSYNA feasibility study (2009) has provided information on the specific demands and requirements of these groups with respect to COSYNA. Ship navigation, coastal defense, oil spill drift forecast, and search and rescue operations are also potential applications of COSYNA products. The general public is a very heterogeneous target group, comprising the less informed and well informed. Far from being homogeneous, "the public" is in fact many different sub-groups. Communication therefore always needs to be tailored to these various groups.

## Results (Highlights)

### Inreach and outreach activities in 2011

The focus of this report is on activities conducted or initiated by COSYNA project management. Other activities such as scientific publications, participation in conferences and trade exhibitions or the further developments of the COSYNA data portal are reported in the respective sections.

A wide range of communication tools is available.

Communication can serve different purposes, e.g. to (purely) spread information or to be more of a dialogue. Communication tools need to be chosen and combined accordingly.

**Official regulations together with legal department:  
COSYNA Contracts**

The general Framework Co-operation Contract provides the regular basis for co-operation in COSYNA and informs about rights and duties of the partners. After thorough consultations and various modifications according to the wishes of the partners, finally, the contract was signed by all partners. In addition, Specific User Contracts for the various instruments provided by HZG to the COSYNA partners were formulated. Main aspects are questions of responsibility for operation and maintenance, liability, and data handling. After specifying these and other aspects together with the partners, the contracts were signed according to the delivery of the instruments.

**COSYNA SharePoint**

The COSYNA SharePoint site is used as a central internal communication hub (see Progress Report 2010). COSYNA sharepoint is limited to the closed circle of COSYNA members, offering the advantages of communication within a closed community. Within the given structure, all COSYNA members can contribute their own content to the COSYNA sharepoint. In 2011 the structure and the communication tools in SharePoint have been adapted to further requirements.

**COSYNA Website**

A new website was designed and setup in the first quarter 2011. COSYNA products and access to the data portal are the first major topics in the navigation menu, followed by a brief overview and the motivation and background of COSYNA. The next main topics are “Observations” and “Modelling” depicting and explaining the various measuring and modelling systems. The central illustration at the homepage with all the measuring equipment deployed in the German Bight, and symbols of data transfer and modelling efforts was designed for COSYNA by an internationally well-known designer (Glynn Gorick). The update and re-design of the website is ongoing.

**Annual Progress Report**

The Progress Report 2010 on selected results, approach to problems and planned activities of the various COSYNA working groups and sub-projects was compiled in April 2011. The Annual Progress Reports are intended for internal information of COSYNA staff members but also available to the public.

**COSYNA Flyer**

The flyer (to date available only in German) is a brief introduction to the COSYNA aims and activities for the general public.

**Workshops & Meetings**

COSYNA meetings and workshops have taken place on a regular basis for and with different target groups. Besides regular meetings of the project management bodies and the working groups that were in particular:

- COSYNA Scientific Steering Committee (CSSC)  
1st April, 2011 / BSH, Hamburg
- COSYNA Workshop  
3rd May, 2011 / AWI, Bremerhaven
- Scientific Advisory Committee (SAC, international panel)  
14 – 15th June, 2011 / HZG
- Evaluation of Product 1 with international evaluators  
2nd Dezember, 2011 / HZG
- COSYNA Scientific Steering Committee (CSSC)  
13rd December, 2011 / BSH, Hamburg

The HZG staff magazine “unter uns” informed all HZG colleagues on the COSYNA SAC meeting.

COSYNA participated in the HZG open day in September 2011 with several activities, e.g. touchscreen, huge jigsaw puzzle, “games”, and give-aways, and was also present at the Hamburg ‘night of knowledge’.



**Figure 1:** Huge COSYNA jigsaw puzzle at the HZG open day in September 2011.

### **Project Management Software (HZG)**

As a pilot project COSYNA uses the Microsoft Project software. With the continued development of the project management software and SAP integration by HZG project administration and controlling, the respective current status of financial and staff resources can be made more transparent to HZG management and employees.

### **Perspectives for 2012**

There are concrete plans to use additional media, e.g.: Newsletter, posters addressing the general public, German and English flyers, social media: contributions to the facebook and twitter sites of HZG, and fact sheets.

The website will be updated to enhance the readability and topicality, additional inframes can give access to recent data and COSYNA products. A user workshop will be held to strengthen the desired two-way information flow by providing for feedback from the (potential) end users of the COSYNA products. A close contact with potential users can ensure an efficient and practise-oriented further development and optimization of the COSYNA products.



# **COSYNA**

## **Coastal Observation System for Northern and Arctic Seas**

Website: [www.cosyna.de](http://www.cosyna.de)

COSYNA data portal: [www.coastlab.org](http://www.coastlab.org)

Helmholtz-Zentrum Geesthacht  
Centre for Materials and Coastal Research  
Institute of Coastal Research  
Dr. Friedhelm Schroeder  
Max-Planck-Straße 1  
21502 Geesthacht  
+49(0)41 52 87-2371  
[friedhelm.schroeder@hzg.de](mailto:friedhelm.schroeder@hzg.de)

Juni 2012

